

1.125" x 1"  
29mm x 25mm

Circumference Range:  
2.5"-4.1"  
64mm-104mm

**Die #2081**

Single/Bifold  
(Has Bottom Matrix)

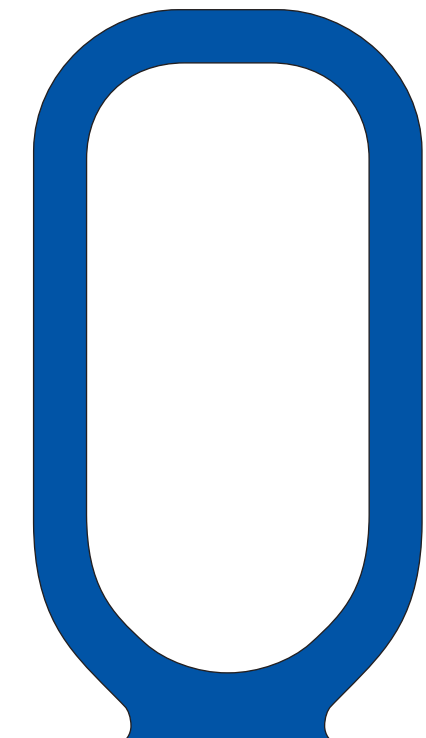

1.125" x 2.25"  
29mm x 57mm

**Full Front Flap**  
Circumference Range:  
9.9"-15.2"  
251mm-386mm

**Die #2381**

Single/Bifold  
(Has Bottom Matrix)

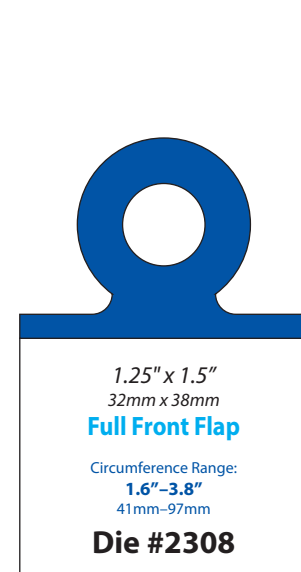

1.25" x 1.5"  
32mm x 38mm

**Full Front Flap**

Circumference Range:  
1.6"-3.8"  
41mm-97mm

**Die #2308**

Single/Bifold  
(Has Bottom Matrix)

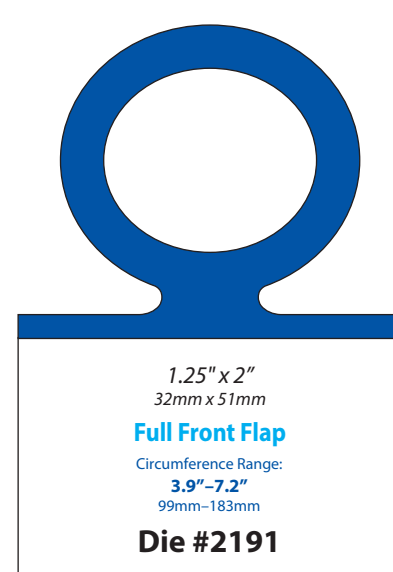

1.25" x 2"  
32mm x 51mm

**Full Front Flap**

Circumference Range:  
3.9"-7.2"  
99mm-183mm

**Die #2191**

Single/Bifold  
(Has Bottom Matrix)

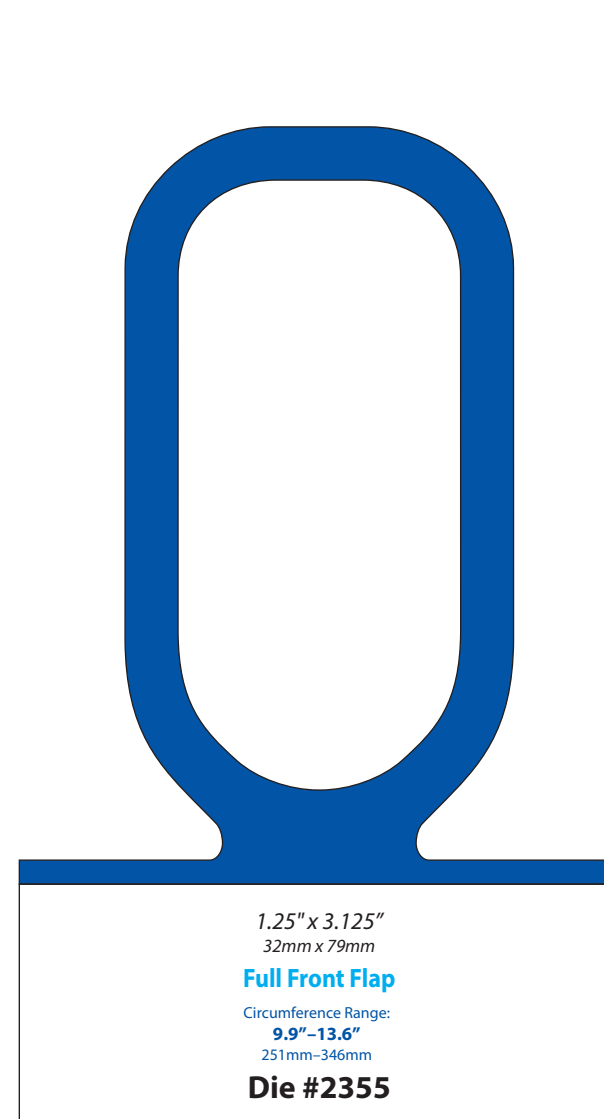

1.25" x 3.125"  
32mm x 79mm

**Full Front Flap**

Circumference Range:  
9.9"-13.6"  
251mm-346mm

**Die #2355**

Single/Bifold  
(Has Bottom Matrix)

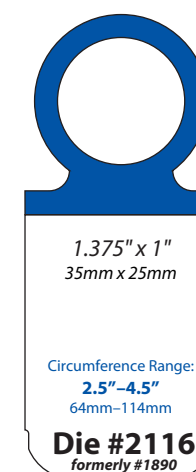

1.375" x 1"  
35mm x 25mm

Circumference Range:  
2.5"-4.5"  
64mm-114mm

**Die #2116**  
formerly #1890

Single/Bifold  
(Has Bottom Matrix)  
Similar to matrix die 2117

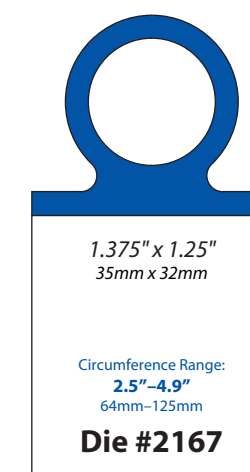

1.375" x 1.25"  
35mm x 32mm

Circumference Range:  
2.5"-4.9"  
64mm-125mm

**Die #2167**

Single/Bifold  
(Has Bottom Matrix)

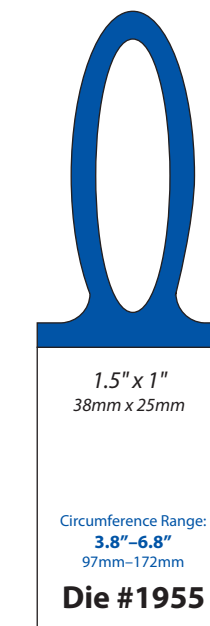

1.5" x 1"  
38mm x 25mm

Circumference Range:  
3.8"-6.8"  
97mm-172mm

**Die #1955**

Single

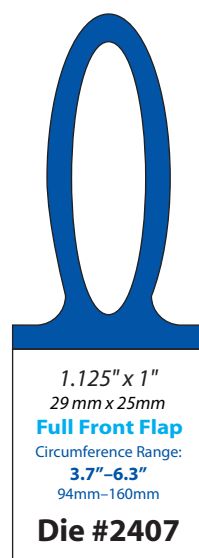

1.125" x 1"  
29mm x 25mm

**Full Front Flap**

Circumference Range:  
3.7"-6.3"  
94mm-160mm

**Die #2407**

Single/Bifold  
(Has Bottom Matrix)

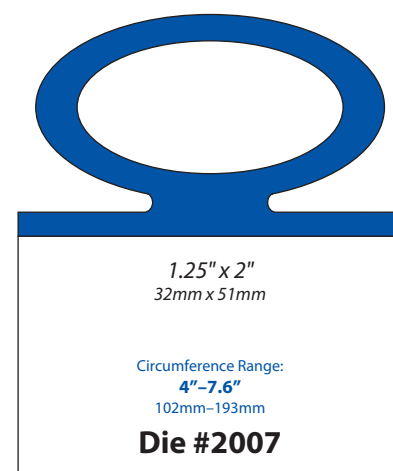

1.25" x 2"  
32mm x 51mm

Circumference Range:  
4"-7.6"  
102mm-193mm

**Die #2007**

Single/Bifold  
(Has Bottom Matrix)

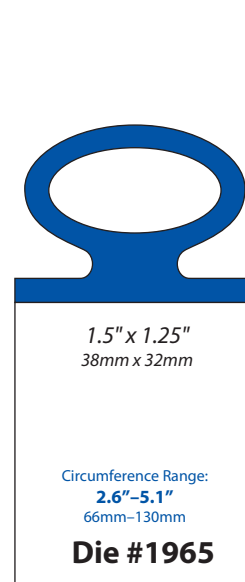

1.5" x 1.25"  
38mm x 32mm

Circumference Range:  
2.6"-5.1"  
66mm-130mm

**Die #1965**

Single/Bifold  
Same as spooled die 2090

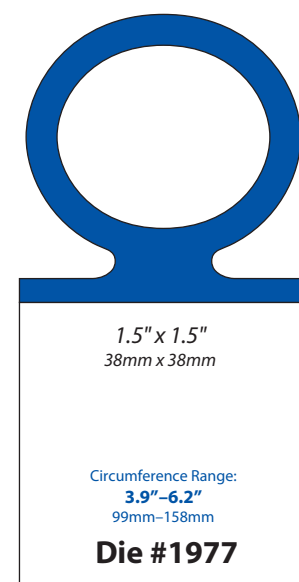

1.5" x 1.5"  
38mm x 38mm

Circumference Range:  
3.9"-6.2"  
99mm-158mm

**Die #1977**

Single

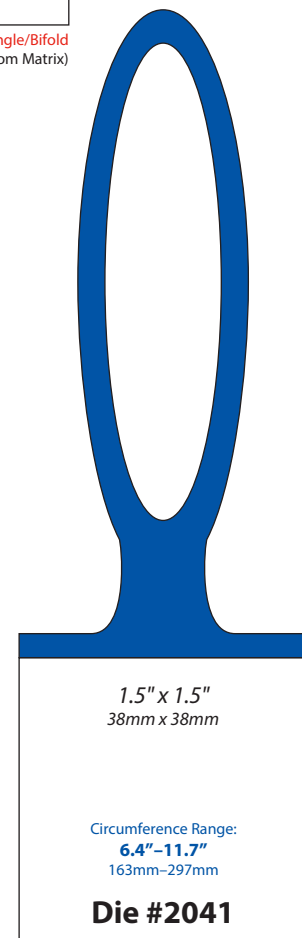

1.5" x 1.5"  
38mm x 38mm

Circumference Range:  
6.4"-11.7"  
163mm-297mm

**Die #2041**

Bifold

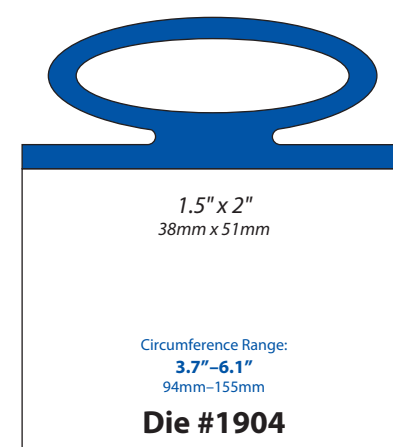

1.5" x 2"  
38mm x 51mm

Circumference Range:  
3.7"-6.1"  
94mm-155mm

**Die #1904**

Bifold

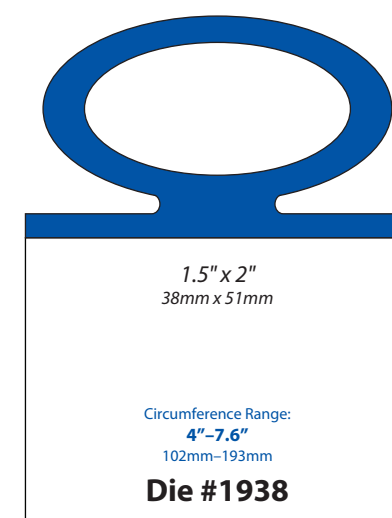

1.5" x 2"  
38mm x 51mm

Circumference Range:  
4"-7.6"  
102mm-193mm

**Die #1938**

Single/Bifold

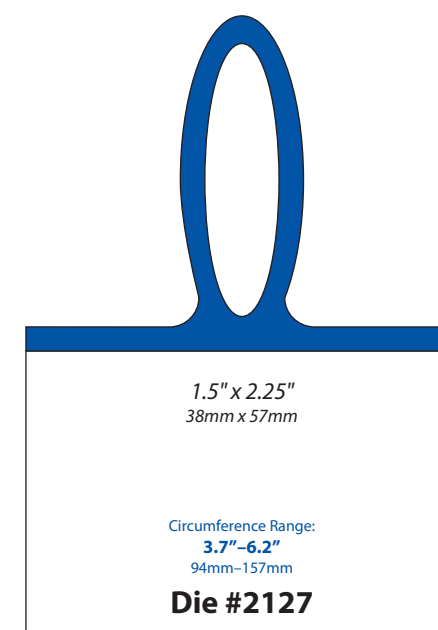

1.5" x 2.25"  
38mm x 57mm

Circumference Range:  
3.7"-6.2"  
94mm-157mm

**Die #2127**

Bifold

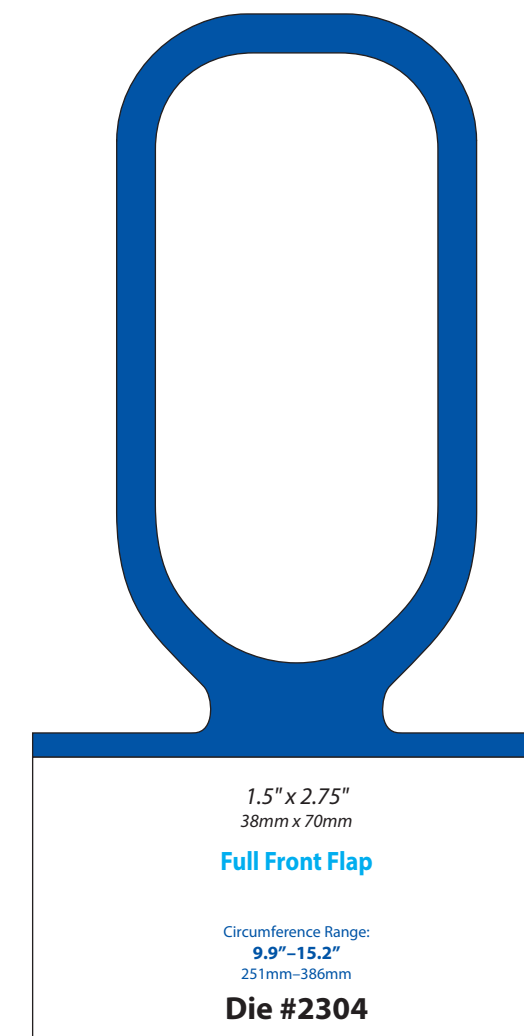

1.5" x 2.75"  
38mm x 70mm

**Full Front Flap**

Circumference Range:  
9.9"-15.2"  
251mm-386mm

**Die #2304**

Single/Bifold  
(Has Bottom Matrix)

- 1904
- 1938
- 1955
- 1965
- 1977
- 2007
- 2041
- 2081
- 2116
- 2127
- 2167
- 2191
- 2304
- 2308
- 2355
- 2381
- 2407

NON-MATRIX

- SPOOLED
- P.O.D. SPOOLED
- TOTE
- MATRIX
- MULTIPANEL
- NF SPOOLED
- TAB
- DUO

- 1821
- 1829
- 1830
- 1922
- 1992
- 2017
- 2043
- 2140
- 2168
- 2225
- 2240
- 2295
- 2453
- 2456
- 2671

1.75" x 1"  
44mm x 25mm

Circumference Range:  
2.5"–4.5"  
64mm–114mm

**Die #2295**

Single

1.75" x 1.5625"  
44mm x 40mm

Circumference Range:  
2.5"–4.1"  
64mm–104mm

**Die #2168**

Single

1.75" x 3"  
44mm x 76mm

Circumference Range:  
4.1"–6.6"  
104mm–168mm

**Die #2140**

Single/Bifold

1.875" x 1"  
48mm x 25mm

Circumference Range:  
3.8"–6.8"  
97mm–172mm

**Die #1821**

Single

2" x 1.25"  
51mm x 32mm

Circumference Range:  
2.5"–4.5"  
64mm–114mm

**Die #2453**

Single

2" x 1.5"  
51mm x 38mm

Circumference Range:  
6.4"–12.8"  
163mm–325mm

**Die #1992**

Single/Bifold

2" x 1.5"  
51mm x 38mm

Circumference Range:  
5.3"–10.4"  
135mm–264mm

**Die #1829**

Single

2" x 1.5"  
51mm x 38mm

Circumference Range:  
6.4"–10.4"  
163mm–264mm

**Die #1830**

Single

2" x 1.5"  
51mm x 38mm

Circumference Range:  
12.8"–22.6"  
325mm–574mm

**Die #2043**

Bifold

2" x 2"  
51mm x 51mm

Circumference Range:  
1.6"–3.8"  
41mm–97mm

**Die #2456**

Single/Bifold

2" x 2.5"  
51mm x 64mm

Circumference Range:  
3.7"–6.0"  
94mm–154mm

**Die #2240**

Single

2" x 1.25"  
51mm x 32mm

Circumference Range:  
3.7"–6.8"  
94mm–173mm

**Die #2671**

Single

2" x 3.5"  
51mm x 89mm

Circumference Range:  
4.5"–7.5"  
115mm–192mm

**Die #2225**

Single

Same as spooled die 2216

2" x 3.5"  
51mm x 89mm

Circumference Range:  
4.1"–7.4"  
104mm–188mm

**Die #2017**

Single

2" x 3.5"  
51mm x 89mm

Circumference Range:  
6.6"–12.3"  
168mm–312mm

**Die #1922**

Single/Bifold

NON-MATRIX

SPOOLED

P.O.D. SPOOLED

TOTE

MATRIX

MULTIPANEL

NF SPOOLED

TAB

DUO

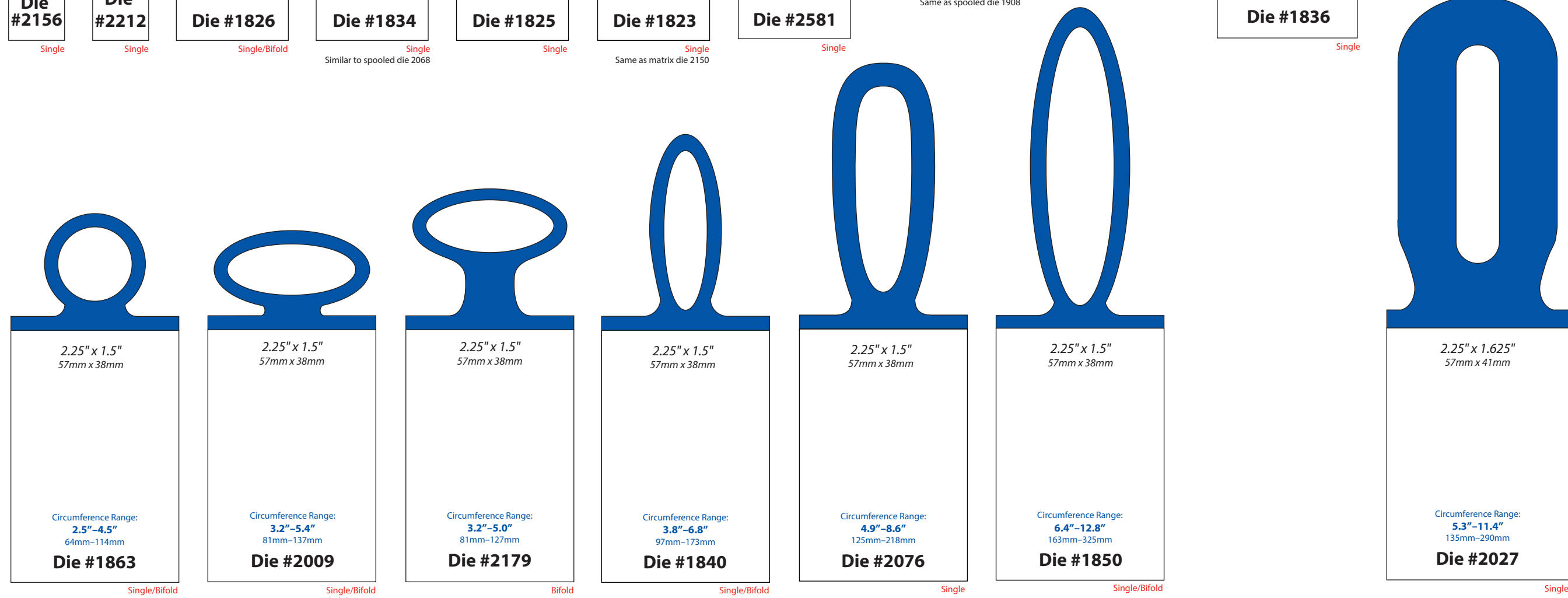
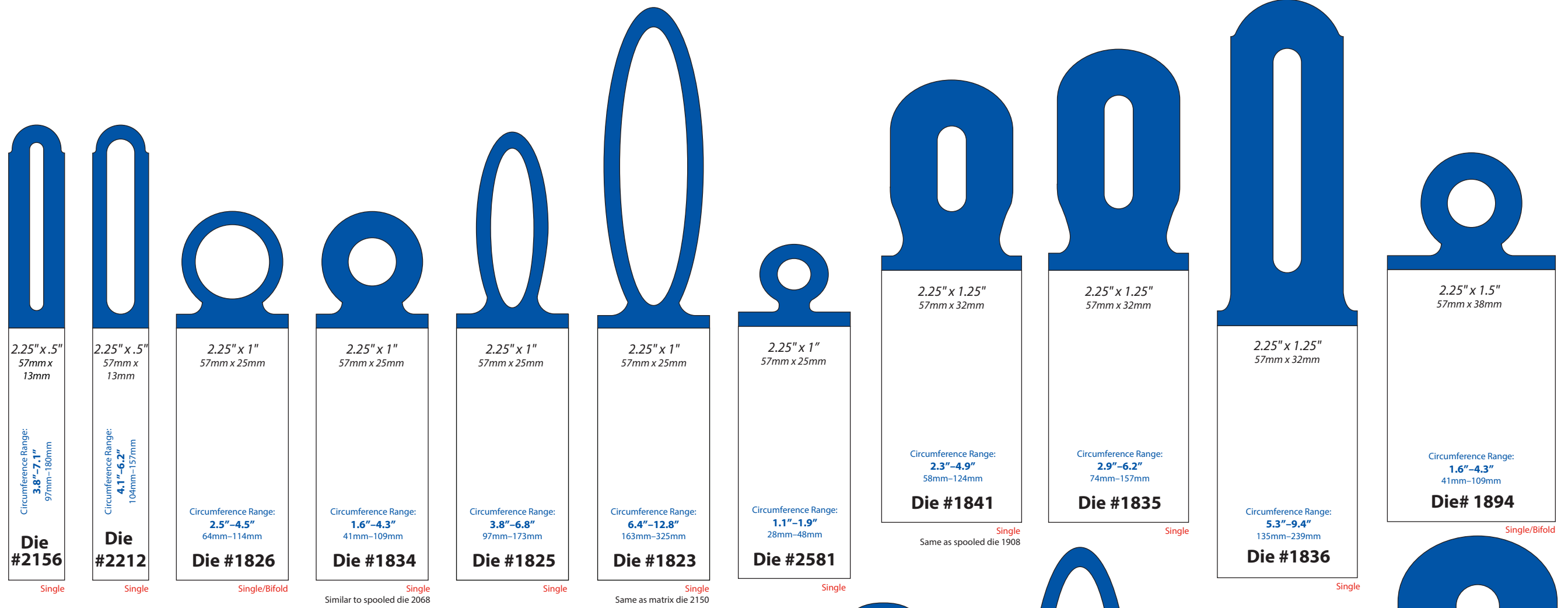

- 1823
- 1825
- 1826
- 1834
- 1835
- 1836
- 1840
- 1841
- 1850
- 1863
- 1894
- 2009
- 2027
- 2076
- 2156
- 2179
- 2212
- 2581

- NON-MATRIX
- SPOOLED
- P.O.D. SPOOLED
- TOTE
- MATRIX
- MULTIPANEL
- NF SPOOLED
- TAB
- DUO

- 1852
- 1862
- 1930
- 1946
- 1957
- 2016
- 2087
- 2188
- 2193
- 2531
- 2647
- 2701
- 2708

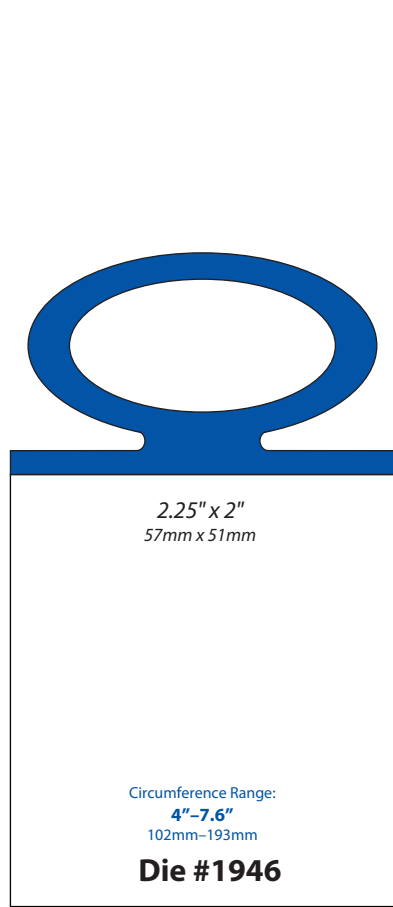

Single/Bifold  
Same as matrix die 2109

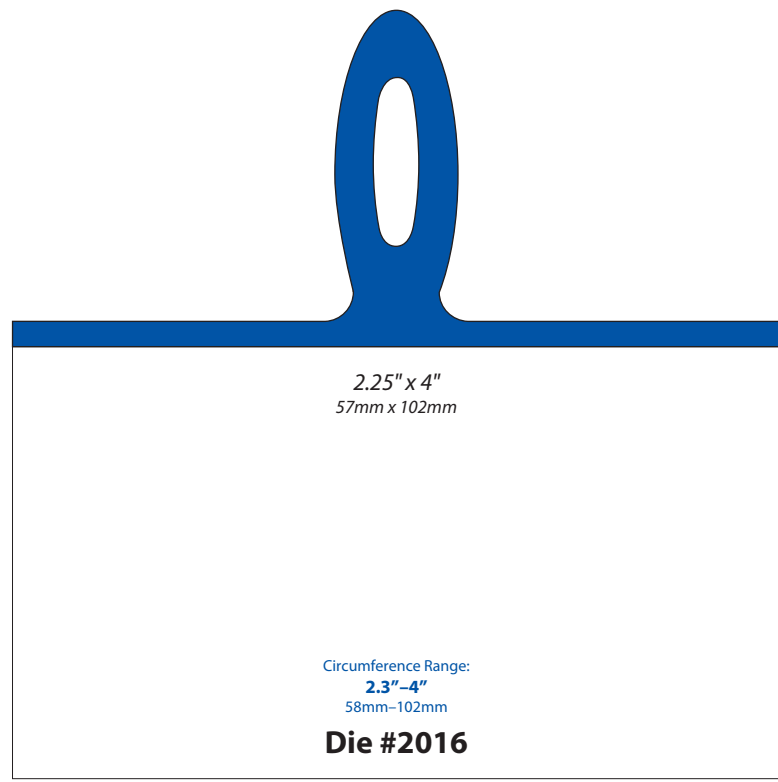

Bifold

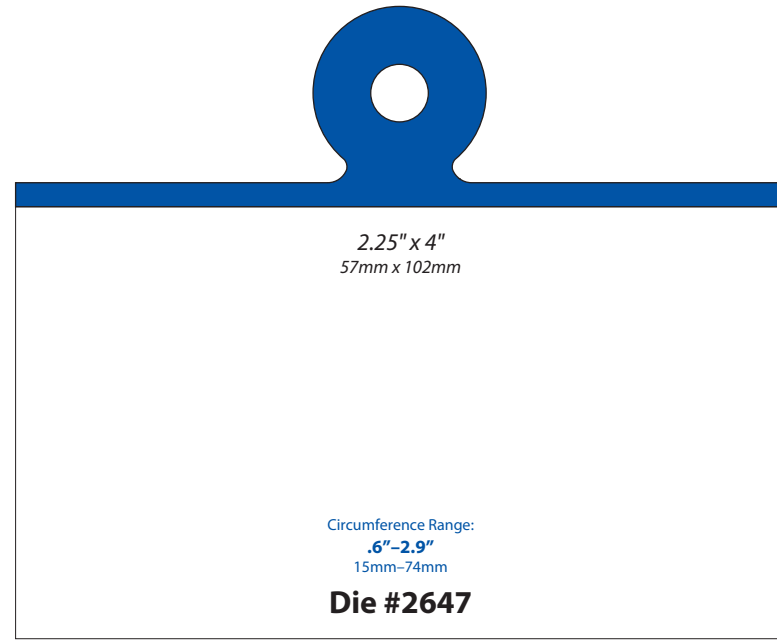

Bifold

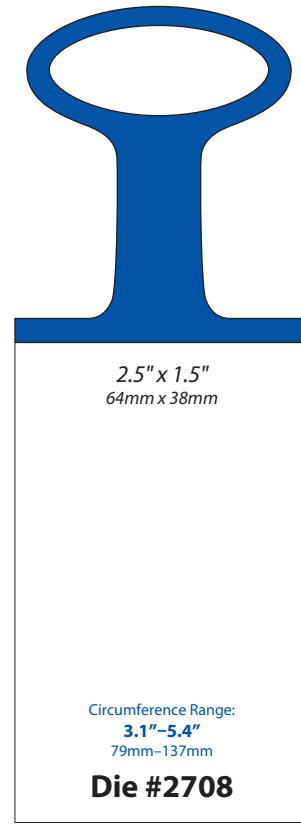

Single

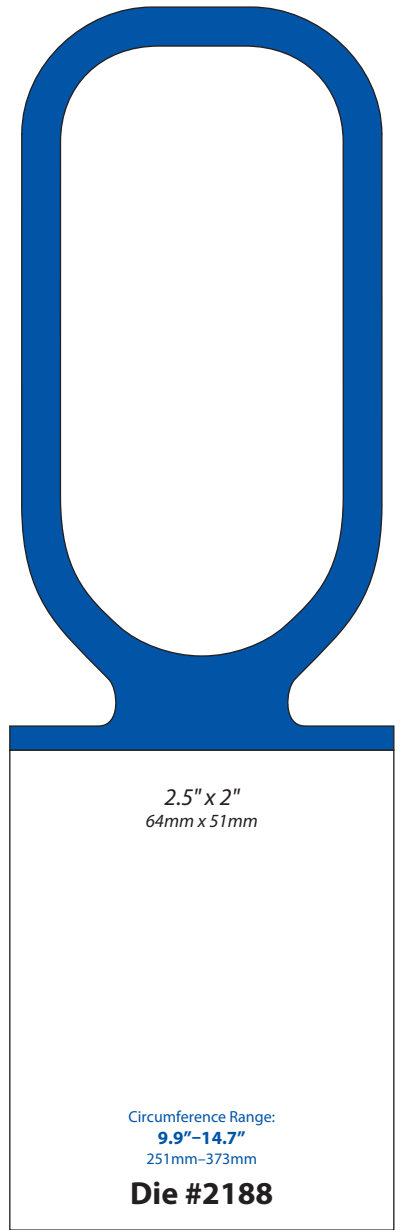

Single/Bifold

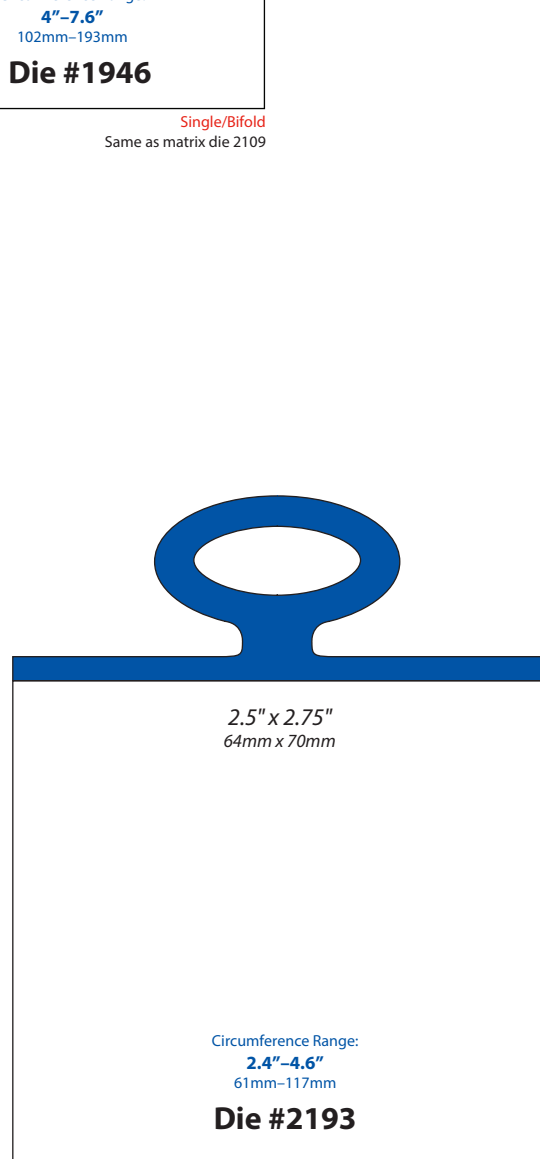

Bifold

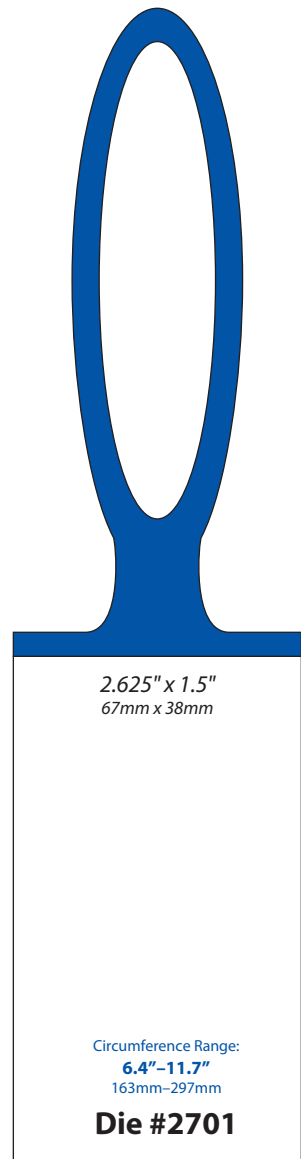

Single

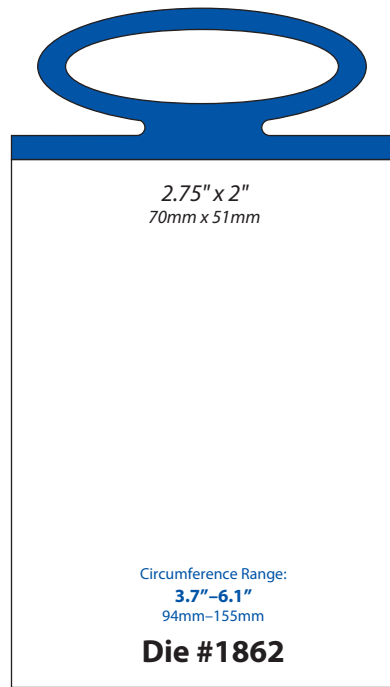

Single/Bifold

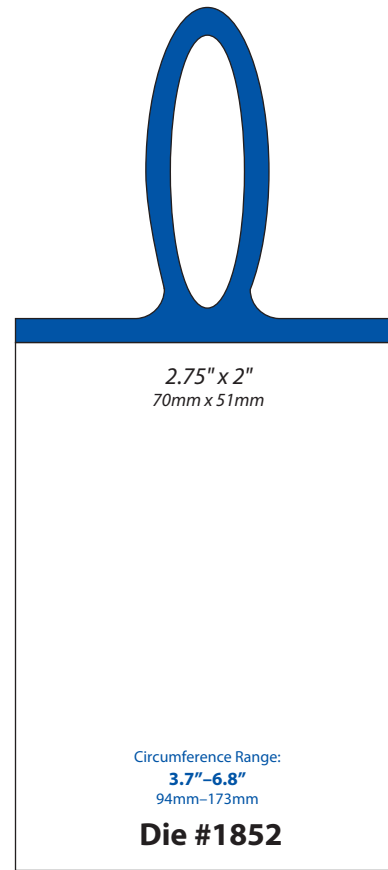

Single/Bifold  
Same as matrix die 2202

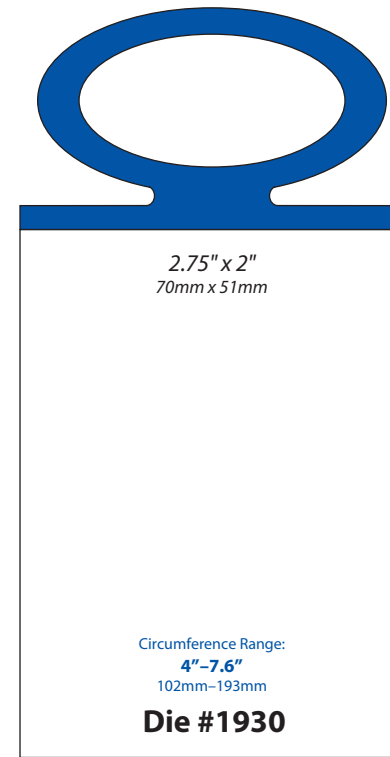

Single/Bifold  
Same as matrix die 2112

NON-MATRIX

SPOOLED

P.O.D. SPOOLED

TOTE

MATRIX

MULTIPANEL

NF SPOOLED

TAB

DUO

- 1831
- 1854
- 1857
- 1864
- 1905
- 1931
- 1957
- 2031
- 2087
- 2100
- 2531
- 2630

NON-MATRIX

SPOOLED

P.O.D. SPOOLED

TOTE

MATRIX

MULTIPANEL

NF SPOOLED

TAB

DUO

ElastiTag®  
BY BEDFORD

Updated: 01/27/23

Patent: elastitag.com/patents

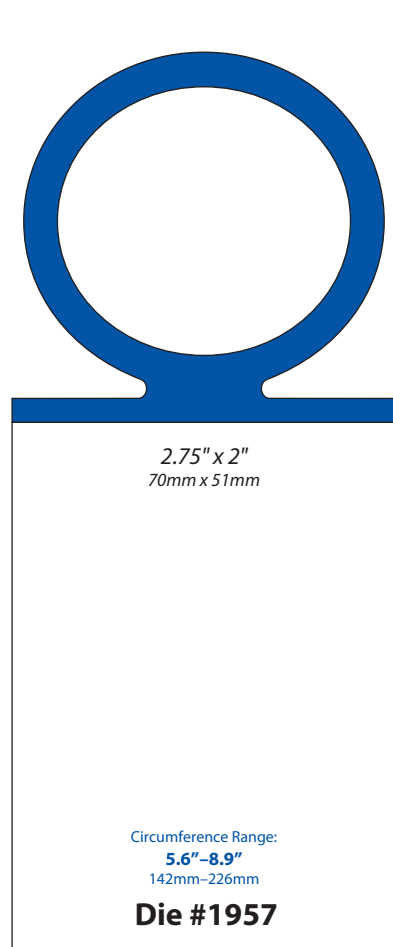

Single/Bifold  
Same as matrix die 2113

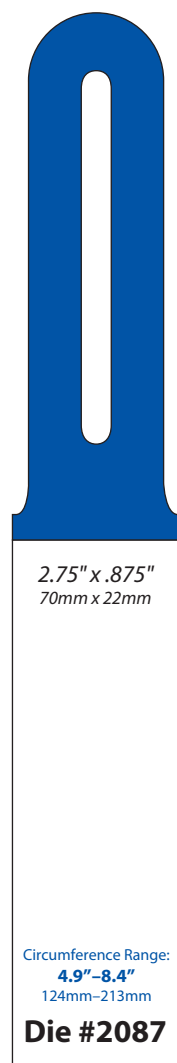

Single

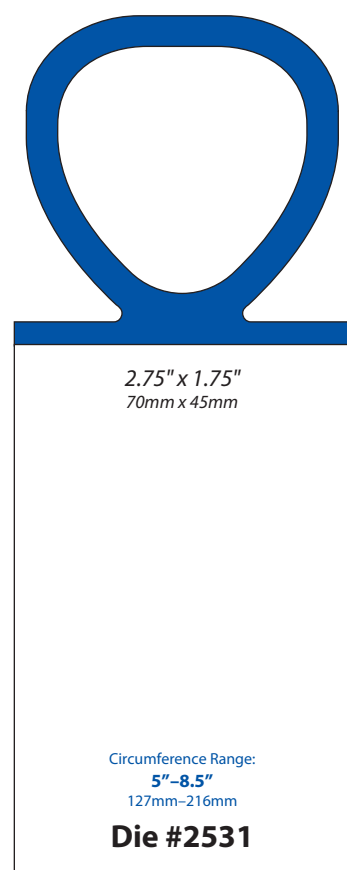

Single

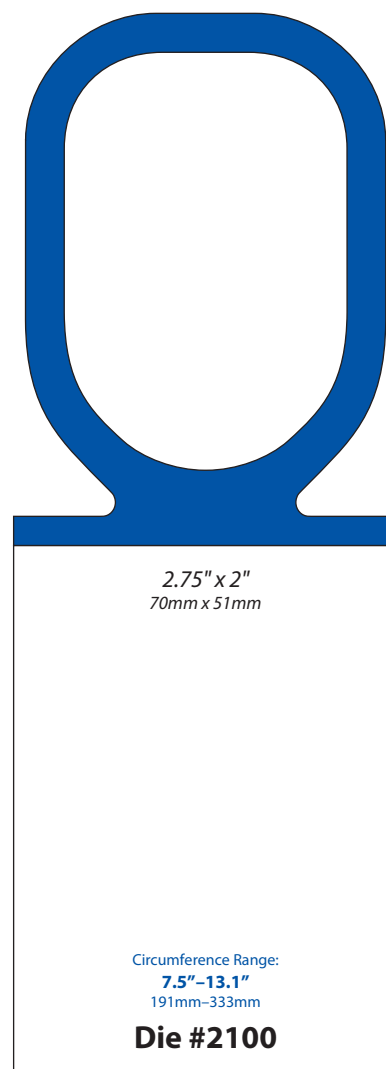

Single/Bifold

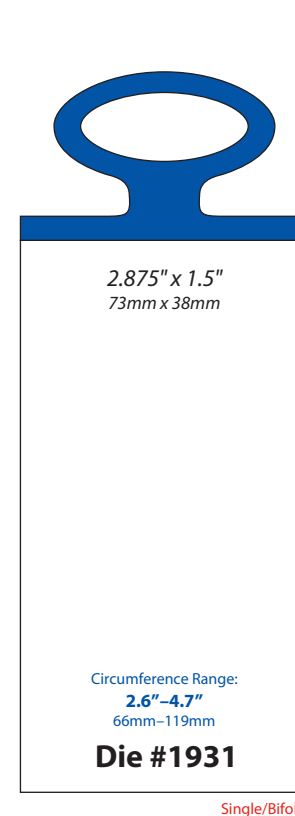

Single/Bifold

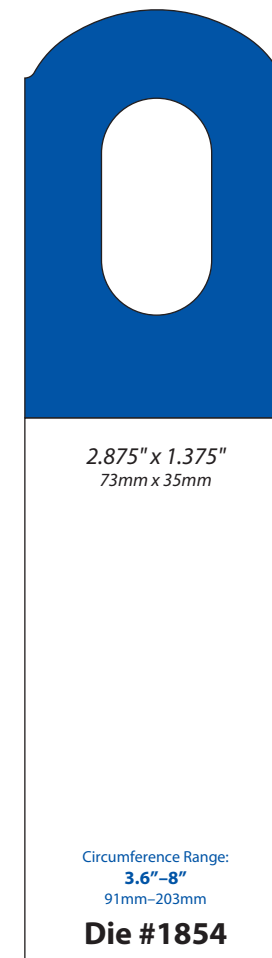

Single  
Same as spooled die 1989

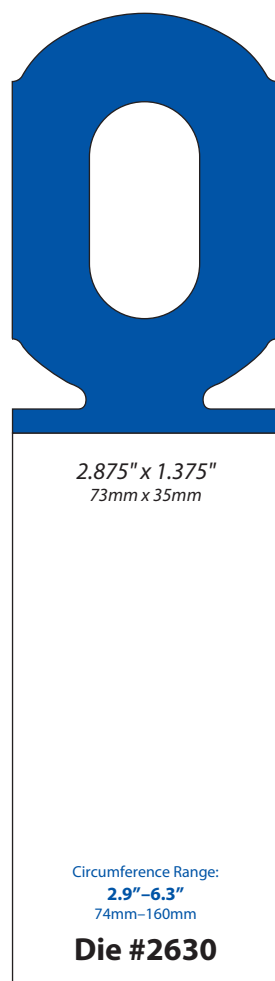

Single/Bifold

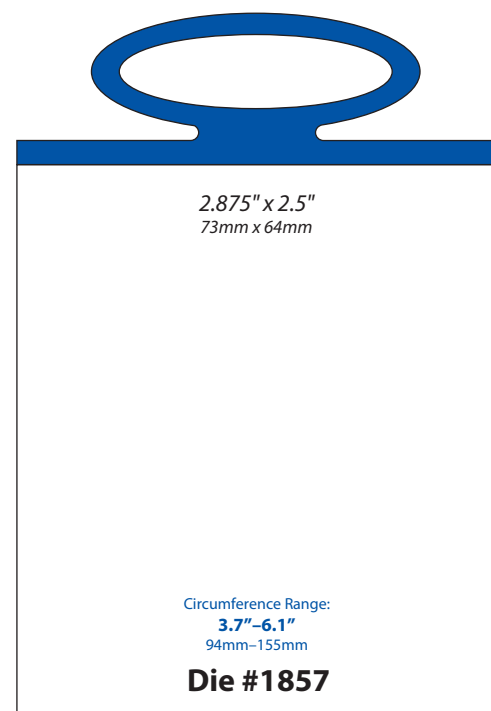

Single/Bifold  
Similar to matrix die 2114

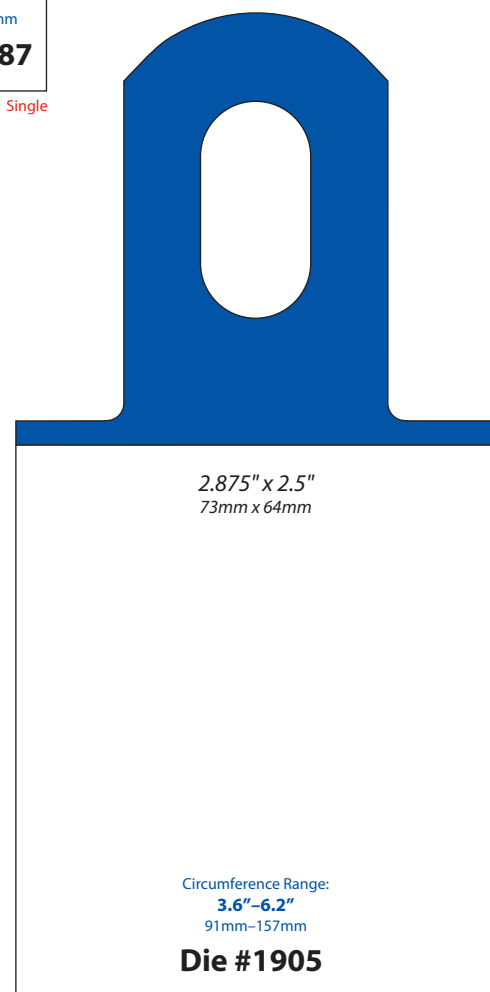

Single

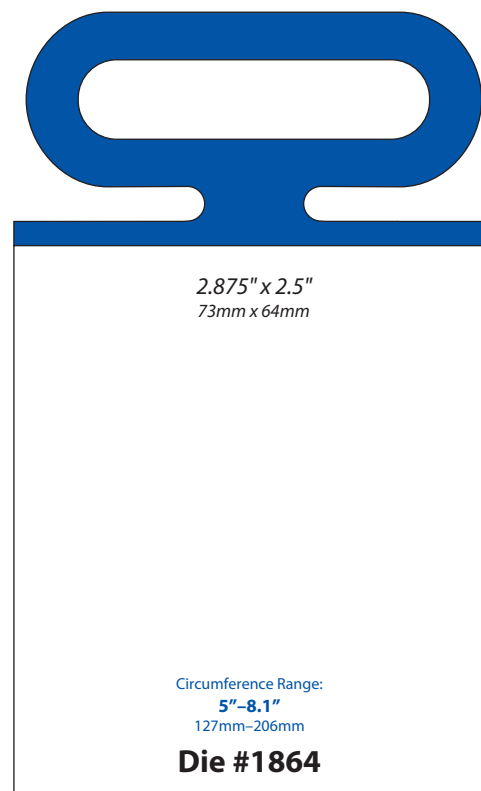

Single/Bifold  
Similar to matrix die 2049

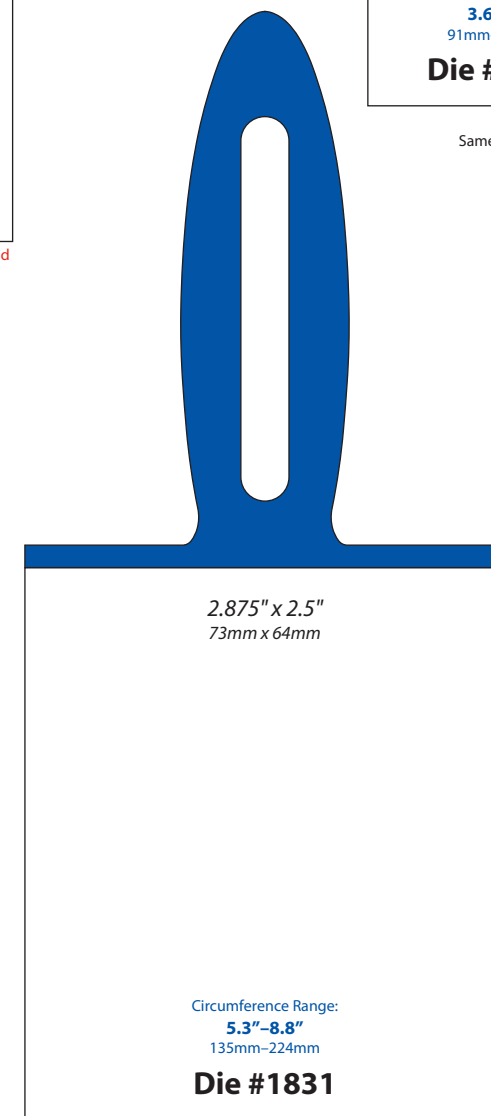

Single

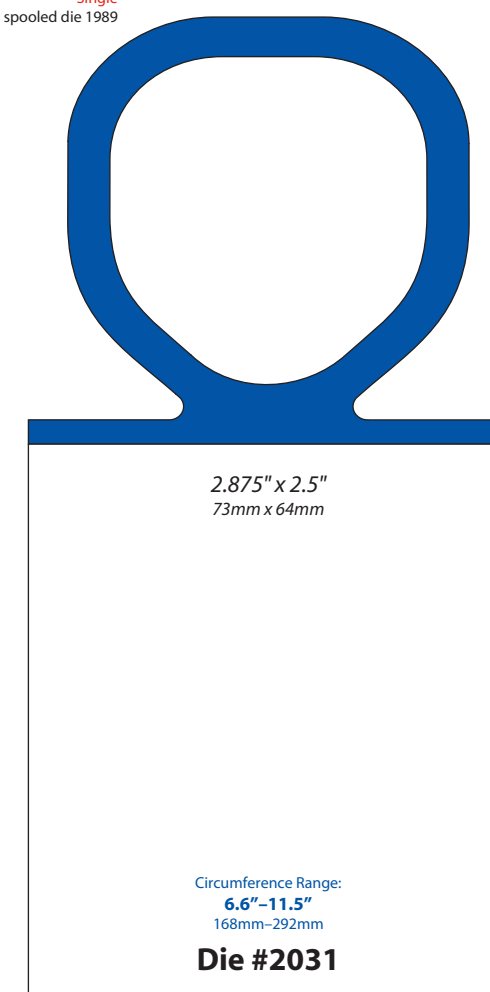

Single

- 1903
- 1907
- 1915
- 1923
- 1942
- 2078
- 2170
- 2566
- 2611
- 2663
- 2700

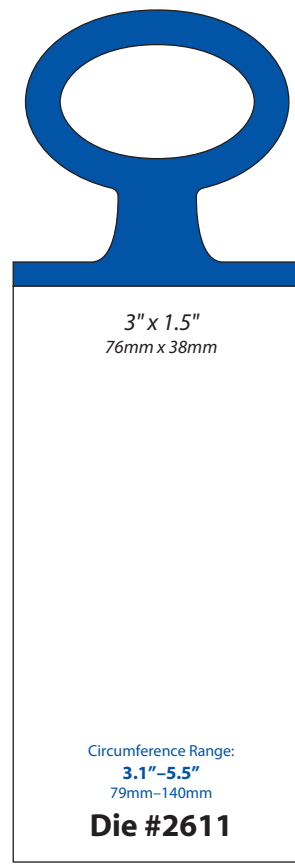

Single

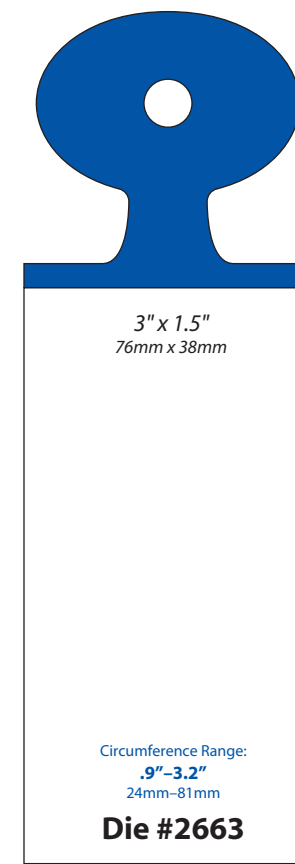

Single

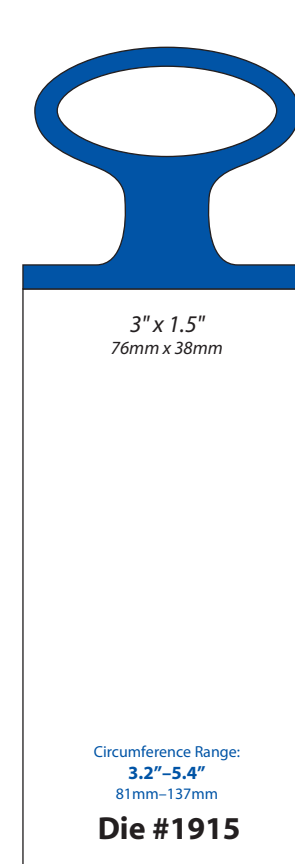

Single/Bifold

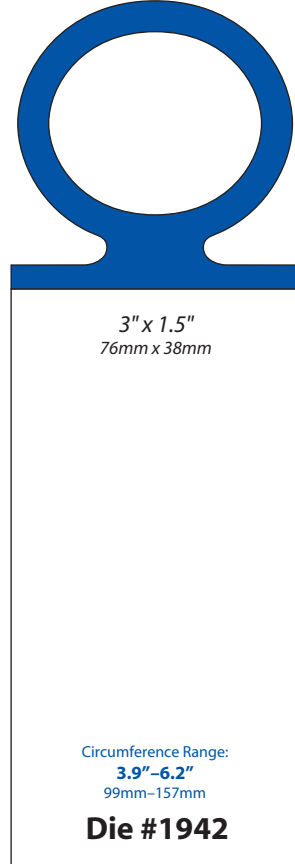

Single/Bifold

Similar to matrix die 1961 Same as matrix die 2110 and spooled die 2030

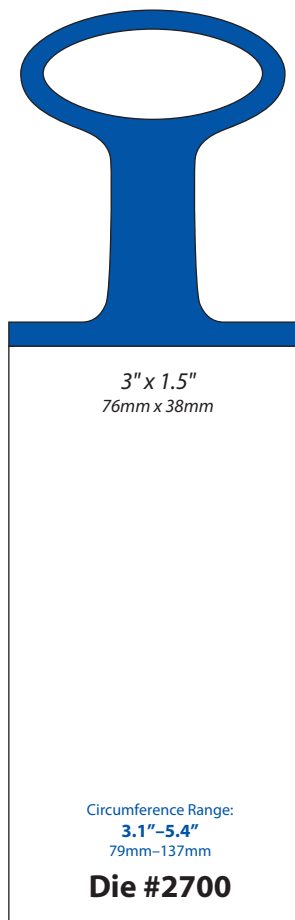

Single

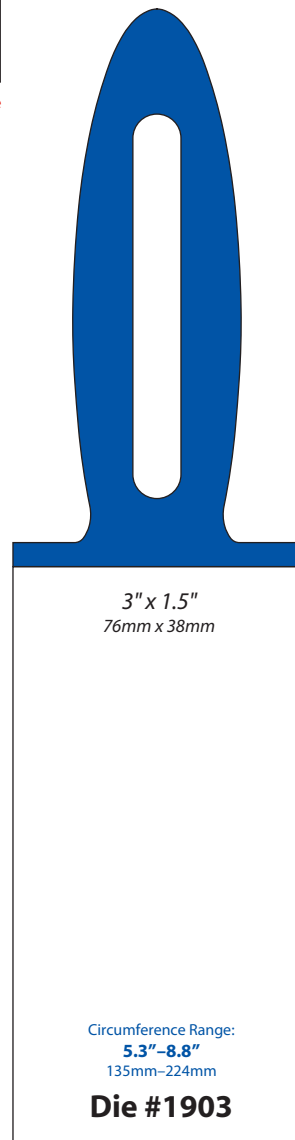

Single

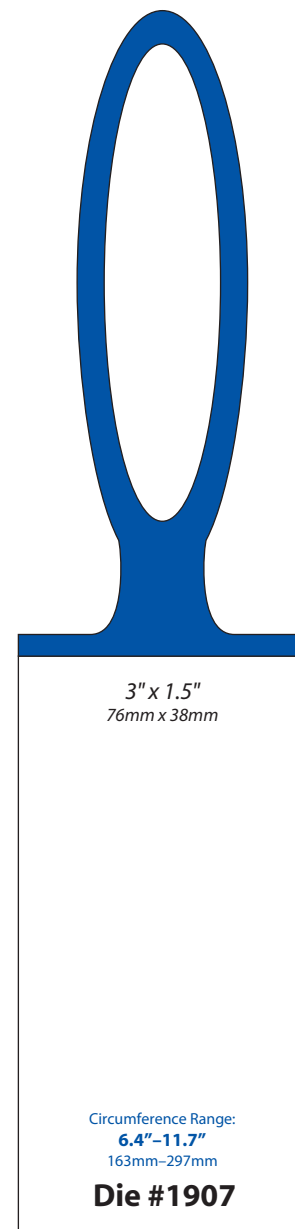

Single/Bifold

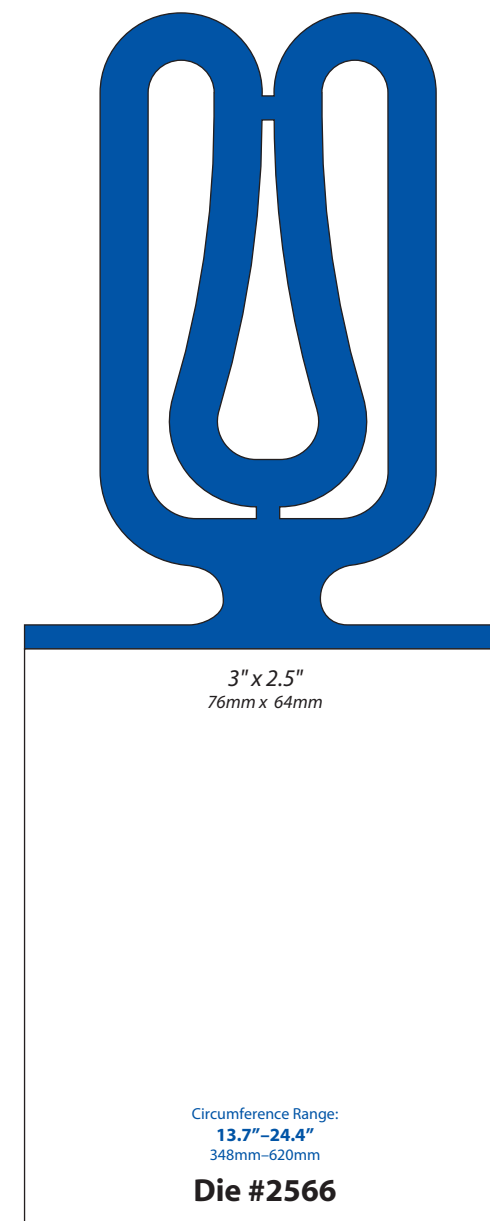

Single

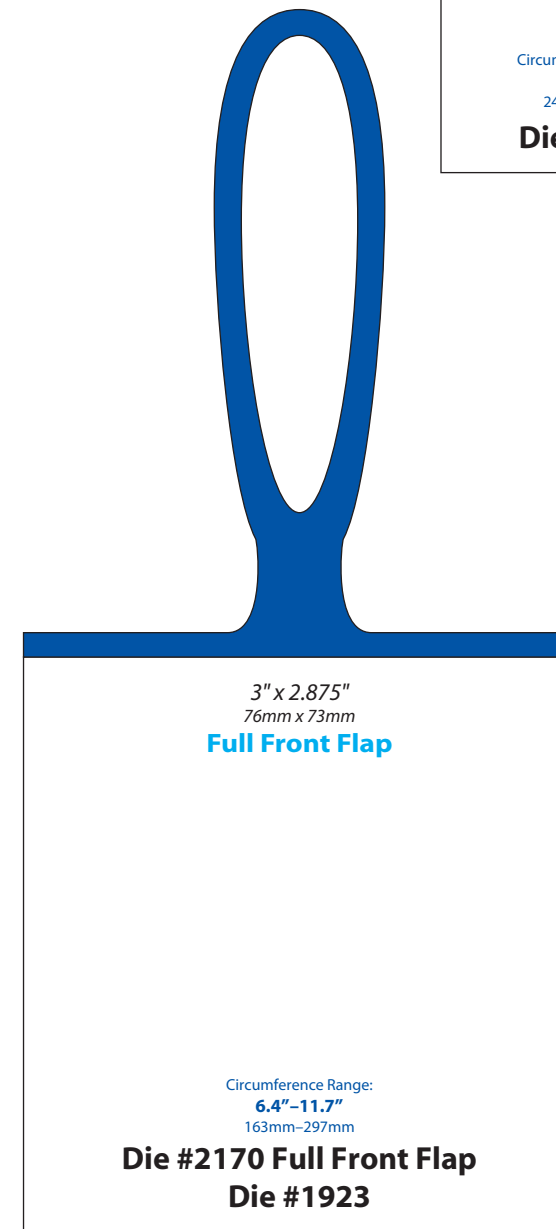

Single/Bifold

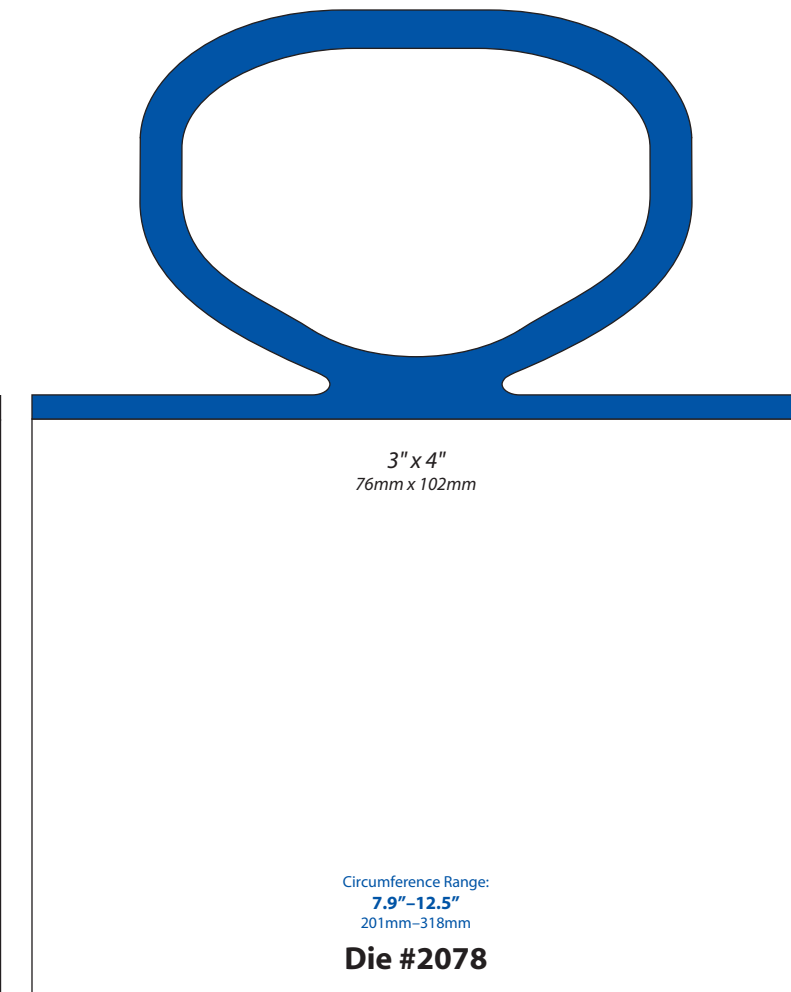

Bifold  
Same as matrix die 2231

**NON-MATRIX**

SPOOLED

P.O.D. SPOOLED

TOTE

MATRIX

MULTIPANEL

NF SPOOLED

TAB

DUO

- 1926
- 1932
- 1982
- 1997

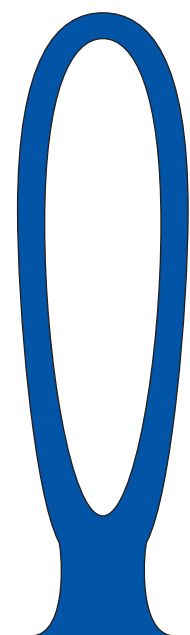

3" x 4"  
76mm x 102mm

Circumference Range:  
6.4"-11.7"  
163mm-297mm

**Die #1932**

Bifold

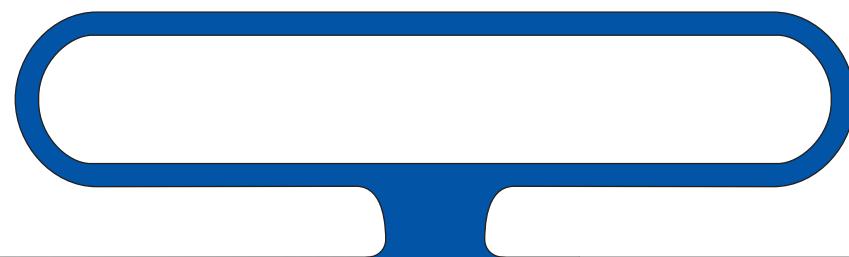

3" x 5"  
76mm x 127mm

Circumference Range:  
11.2"-16.2"  
284mm-411mm

**Die #1926**

Single/Bifold

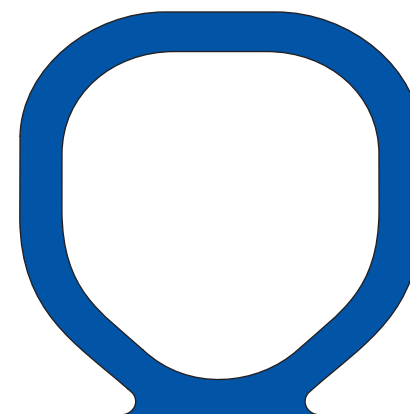

3.25" x 2.75"  
83mm x 70mm

Circumference Range:  
6.6"-11.5"  
167mm-292mm

**Die #1997**

Single

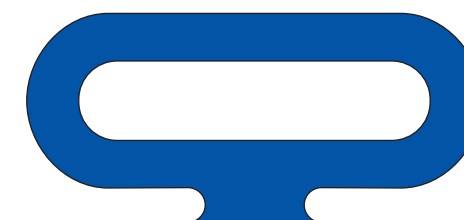

3.46875" x 2.5"  
88mm x 64mm

Circumference Range:  
5"-8.1"  
127mm-206mm

**Die #1982**

Single

**NON-MATRIX**

SPOOLED

P.O.D. SPOOLED

TOTE

MATRIX

MULTIPANEL

NF SPOOLED

TAB

DUO

- 1832
- 1917
- 2008
- 2028
- 2198
- 2220
- 2252

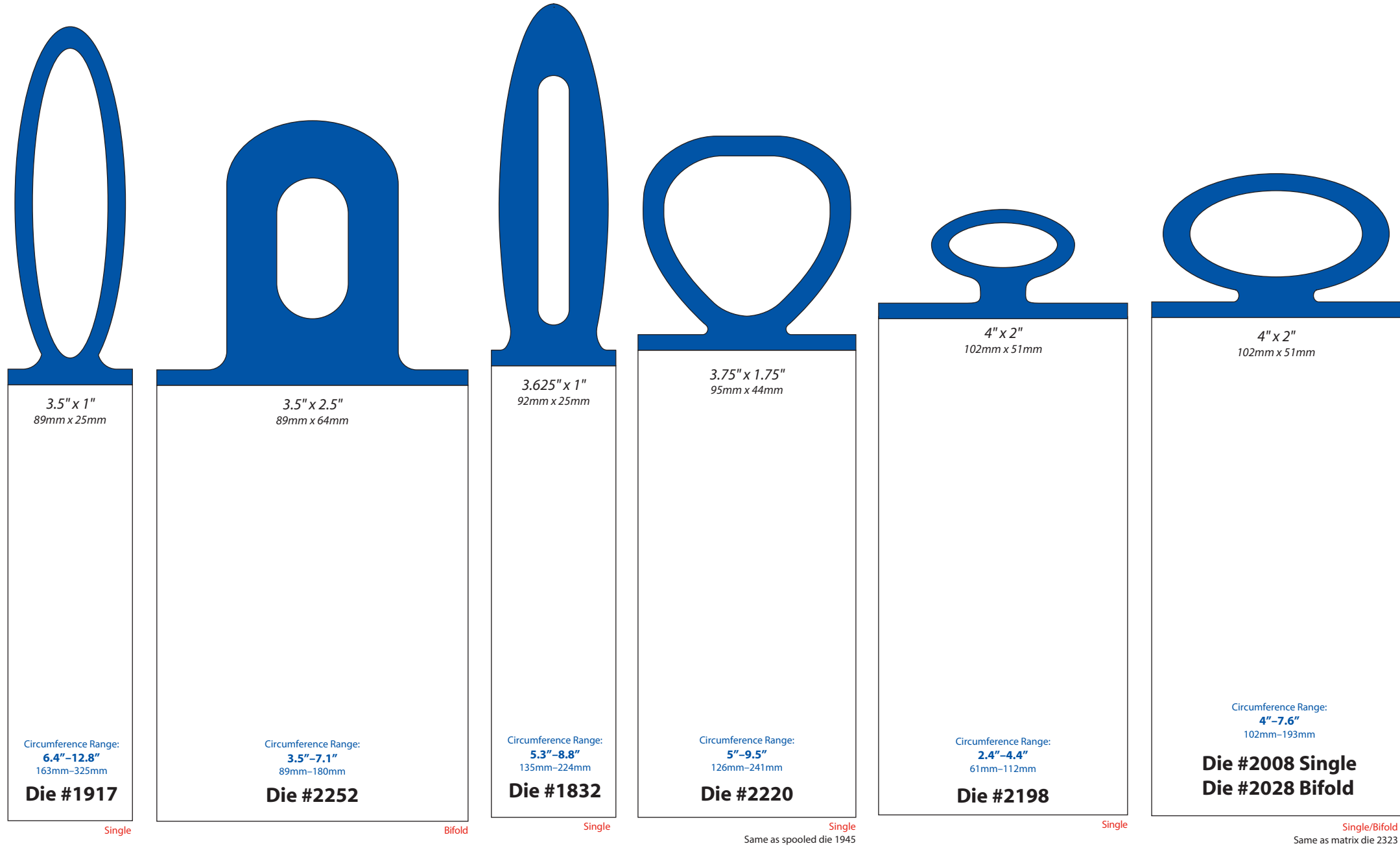

NON-MATRIX

SPOOLED

P.O.D. SPOOLED

TOTE

MATRIX

MULTIPANEL

NF SPOOLED

TAB

DUO



1895

2282

2669

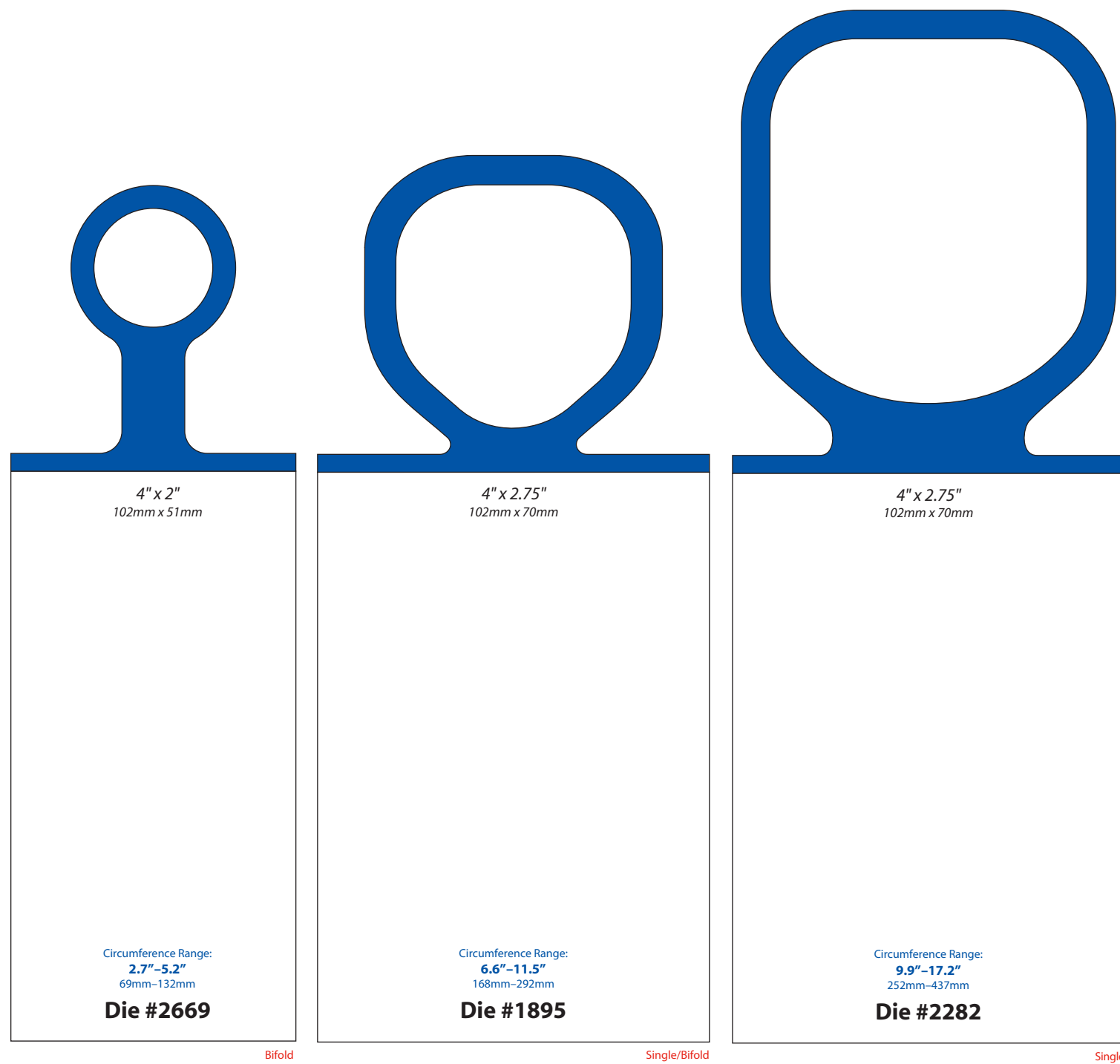

NON-MATRIX

SPOOLED

P.O.D. SPOOLED

TOTE

MATRIX

MULTIPANEL

NF SPOOLED

TAB

DUO

2369

2402

2678

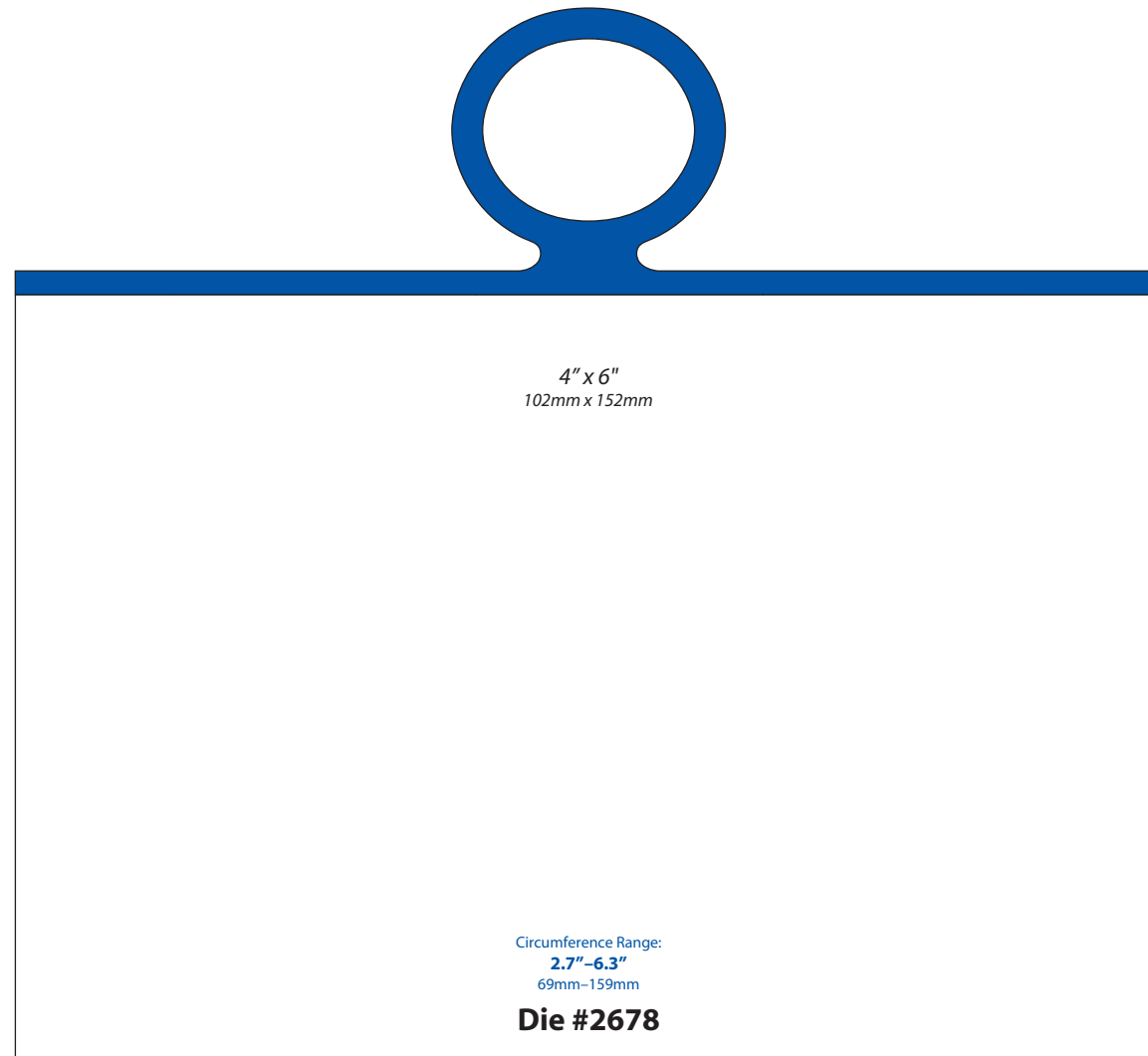

Single

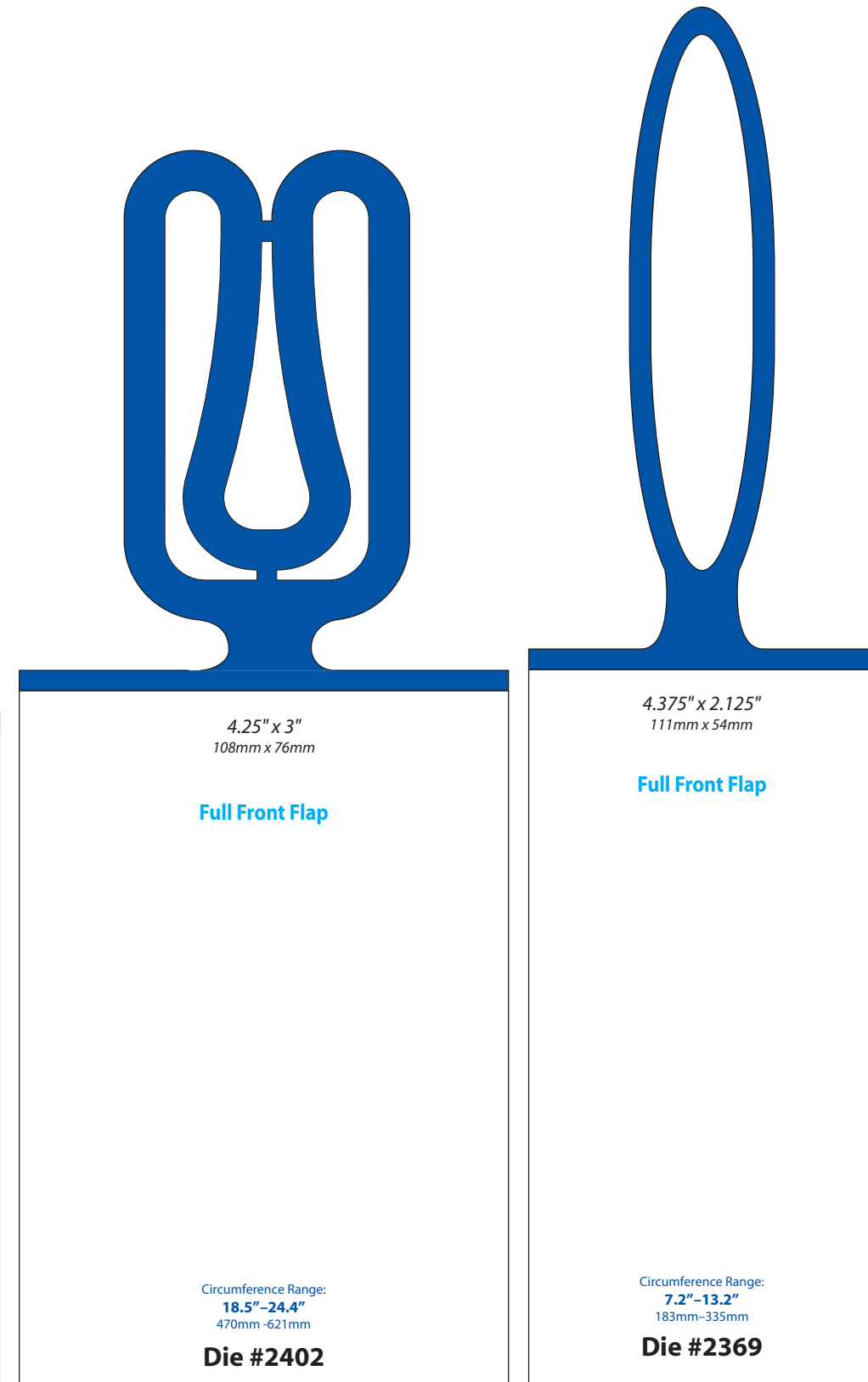

Single/Bifold  
(Has Bottom Matrix)

Single/Bifold  
(Has Bottom Matrix)

NON-MATRIX

SPOOLED

P.O.D. SPOOLED

TOTE

MATRIX

MULTIPANEL

NF SPOOLED

TAB

DUO

- 1943
- 1949
- 2001
- 2025
- 2029
- 2104

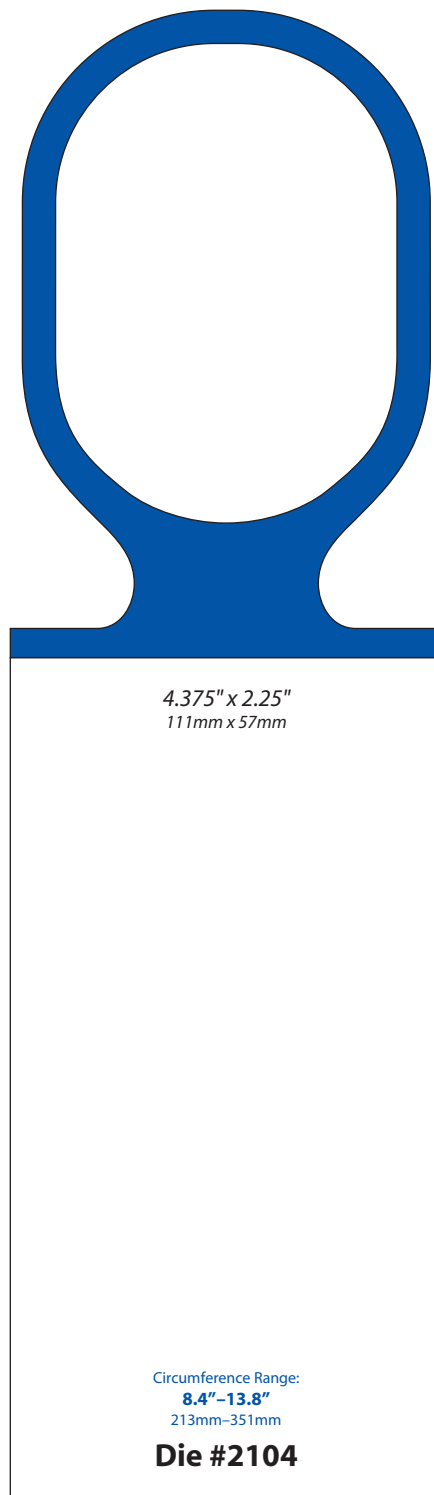

Bifold

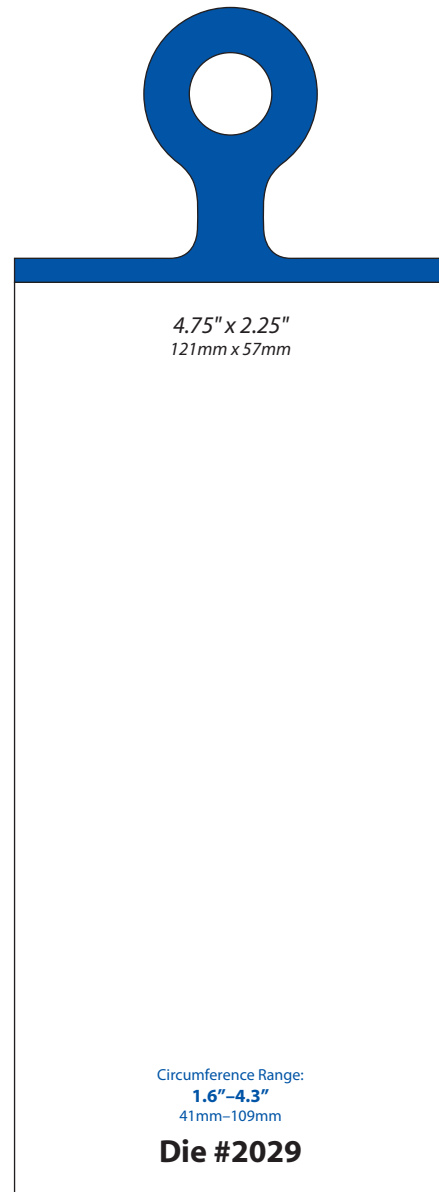

Single

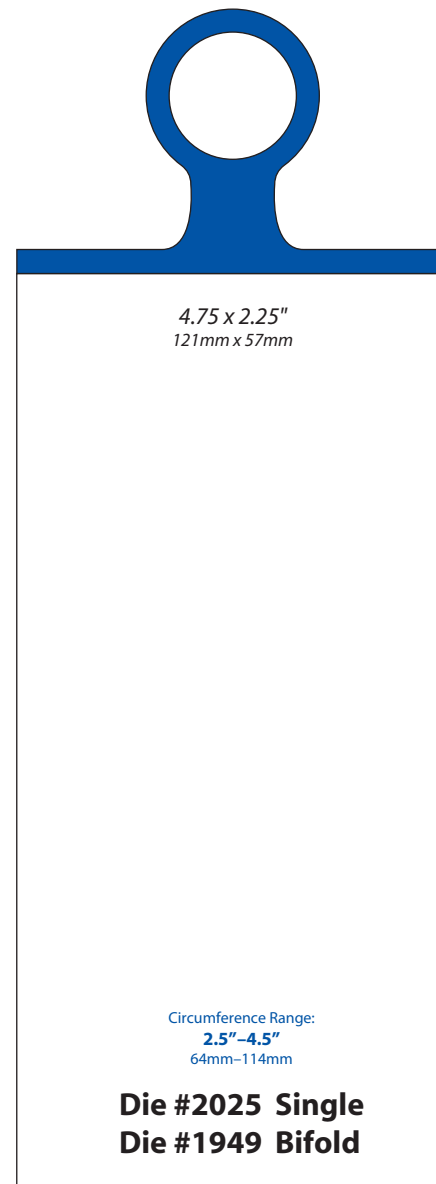

Single/Bifold

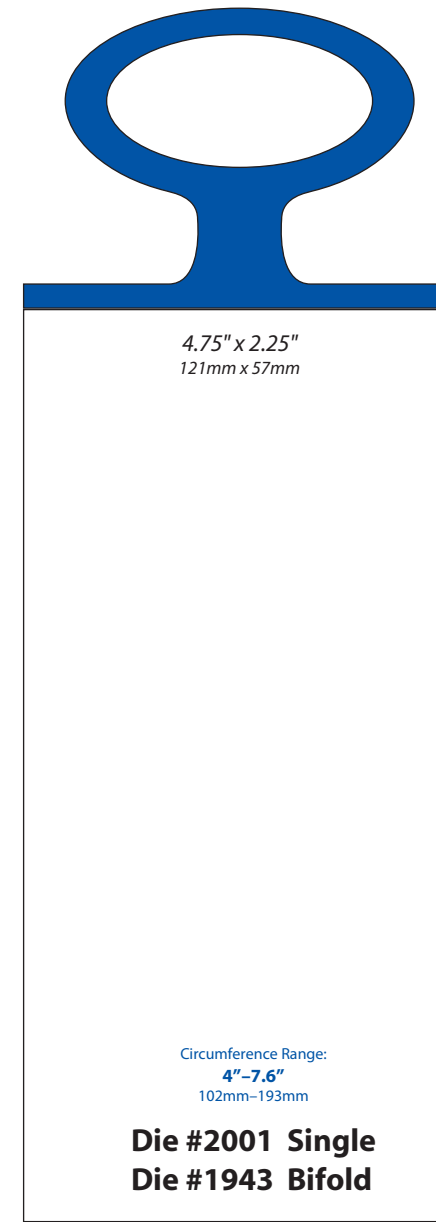

Single/Bifold

**NON-MATRIX**

SPOOLED

P.O.D. SPOOLED

TOTE

MATRIX

MULTIPANEL

NF SPOOLED

TAB

DUO

- 1916
- 1983
- 1999
- 2032
- 2187

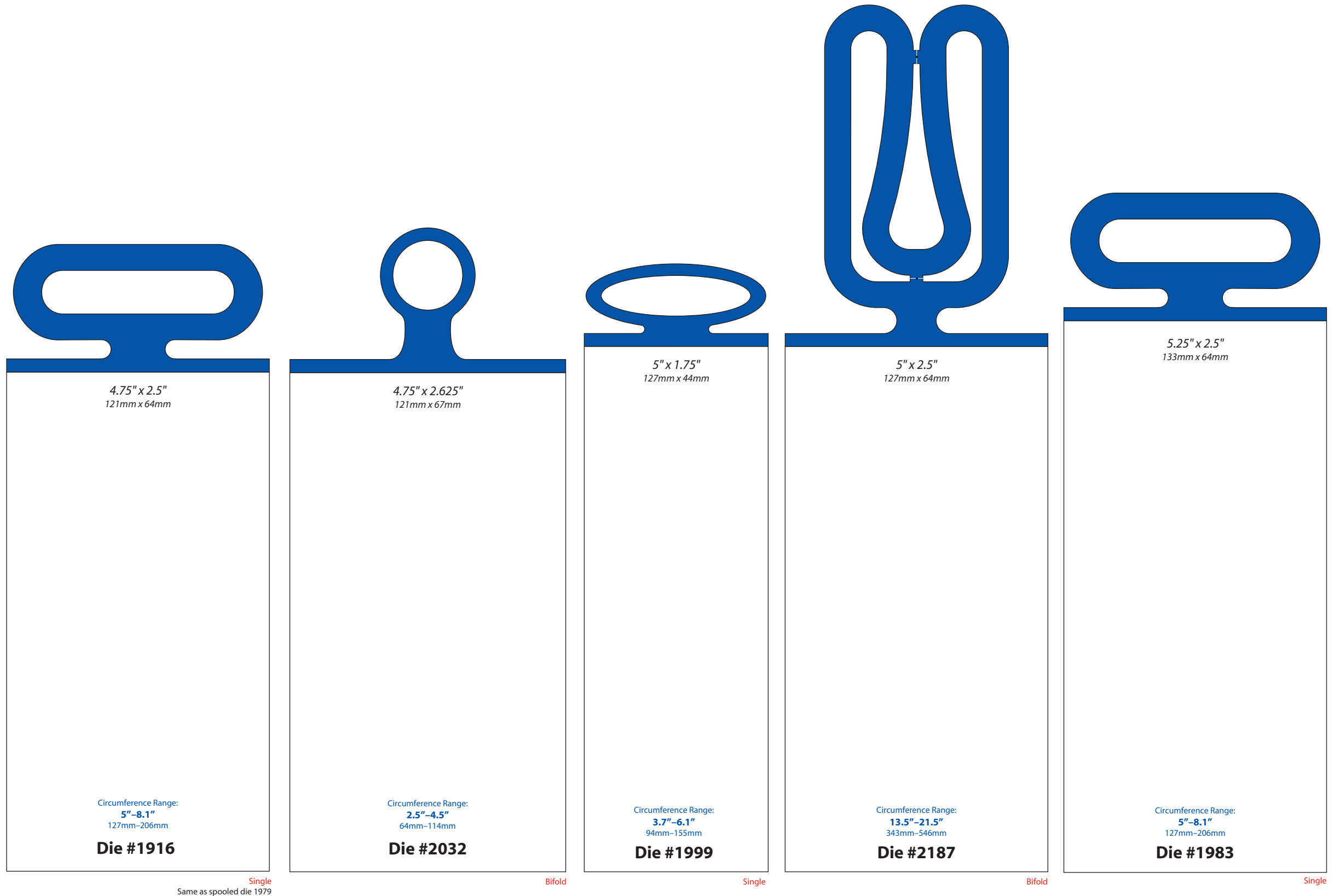

NON-MATRIX

SPOOLED

P.O.D. SPOOLED

TOTE

MATRIX

MULTIPANEL

NF SPOOLED

TAB

DUO

2064

2091

2290

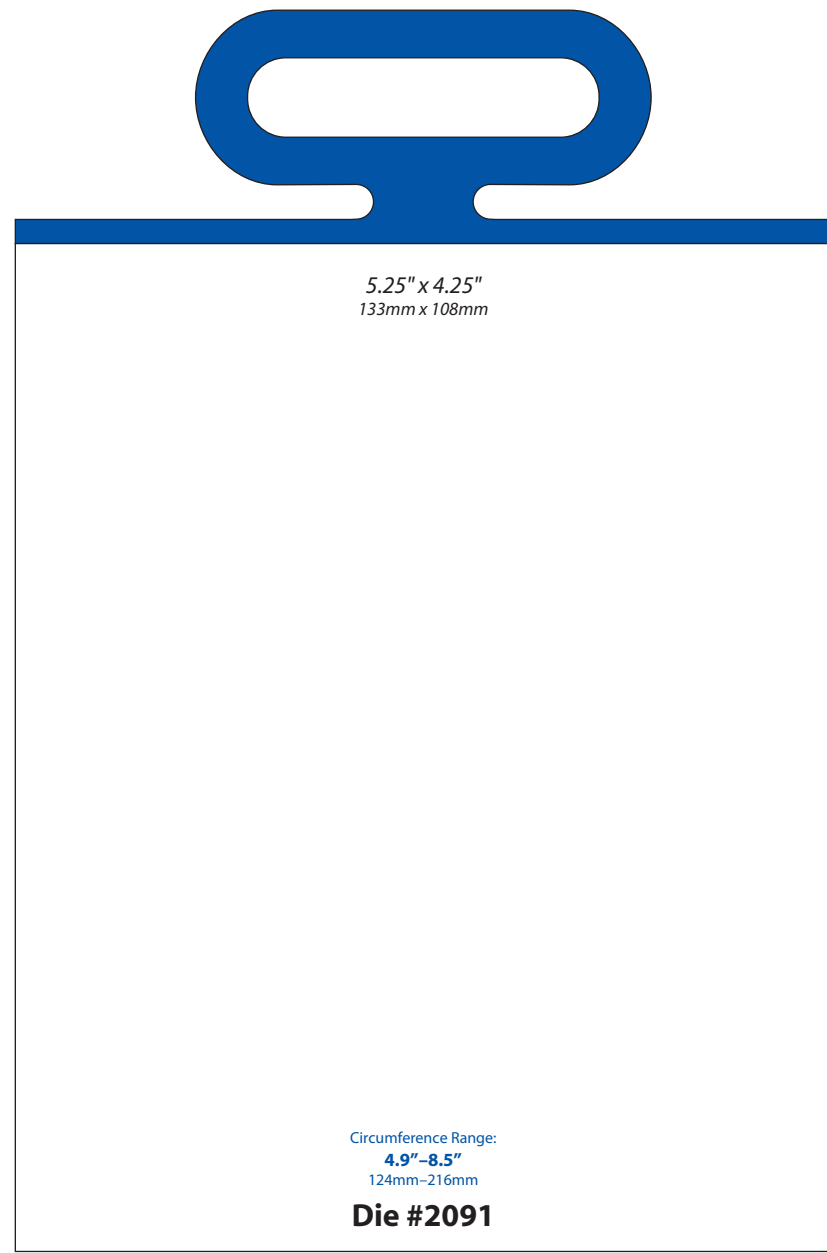

Single

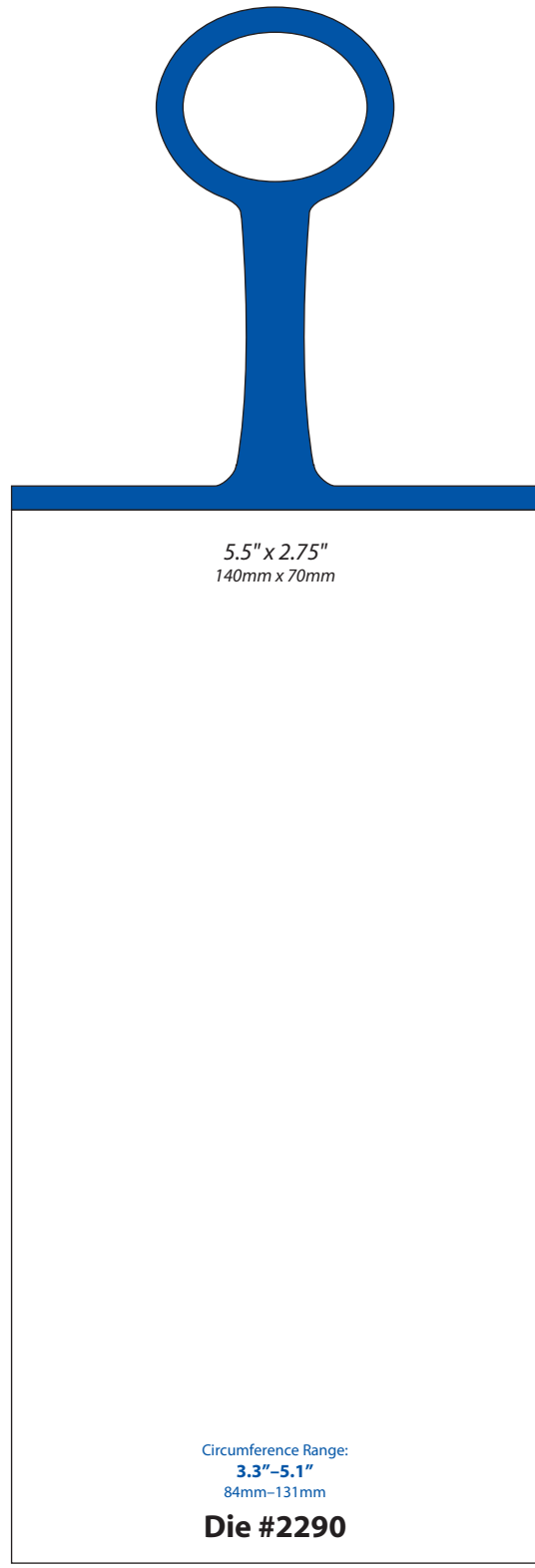

Single

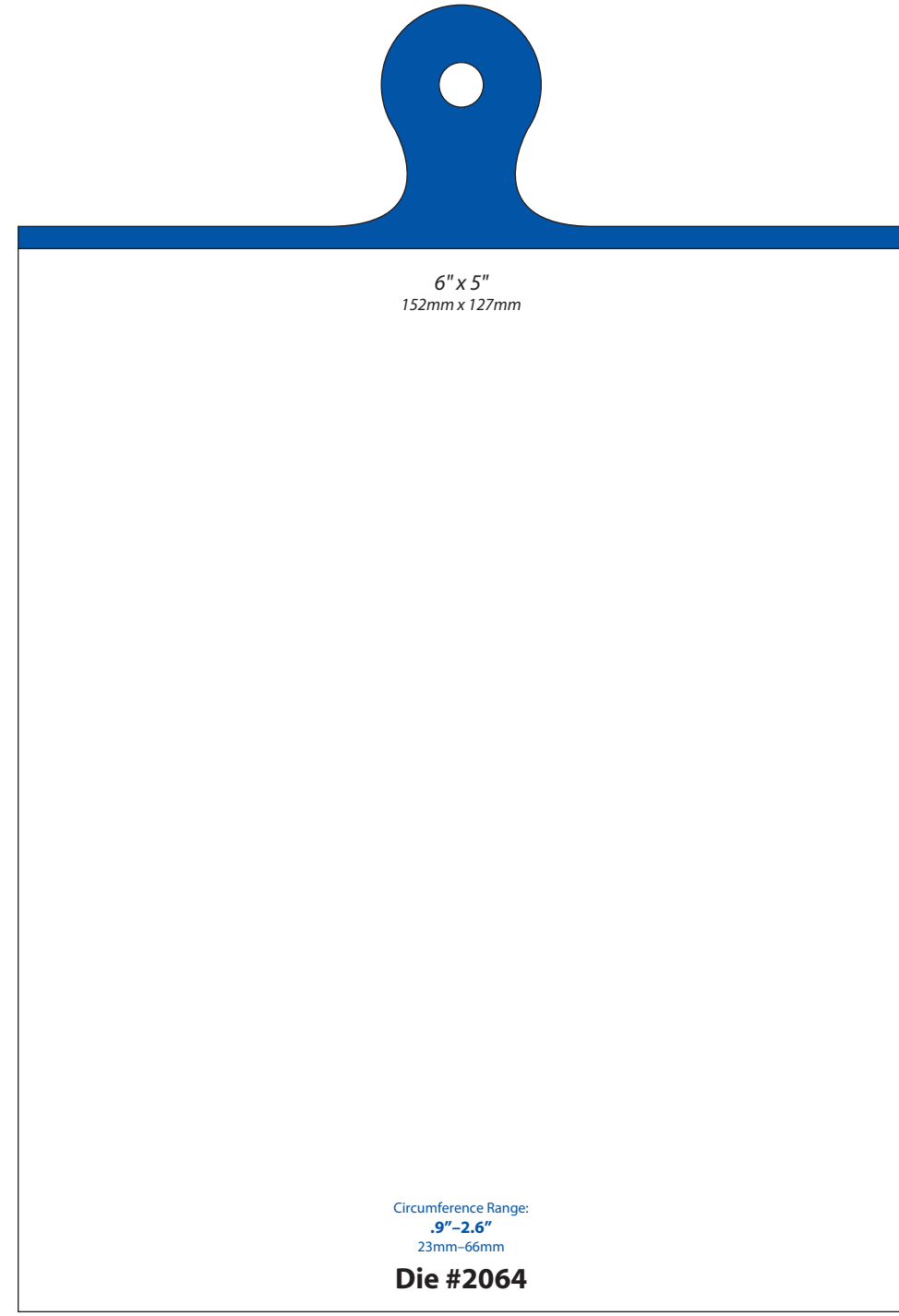

Single

- NON-MATRIX**
- SPOOLED
- P.O.D. SPOOLED
- TOTE
- MATRIX
- MULTIPANEL
- NF SPOOLED
- TAB
- DUO

- 1842
- 1856
- 1908
- 2003
- 2058
- 2068
- 2077
- 2090
- 2171
- 2186
- 2209
- 2216
- 2218
- 2334
- 2351
- 2374
- 2375

Die #	Dimensions	Circumference Range	Notes
Die #2090	1.5" x 1.25" 38mm x 32mm	2.6"-4.6" 66mm-117mm	Single Same as standard die 1965
Die #2375	1.5625" x 1.375" 40mm x 35mm	3"-5.5" 76mm-140mm	Single/Bifold (Has Bottom Matrix)
Die #2374	1.5625" x 1.5625" 40mm x 40mm	3"-4.7" 76mm-119mm	Single/Bifold (Has Bottom Matrix)
Die #2334	1.5625" x 2" 40mm x 51mm	3"-4.7" 76mm-119mm	Single/Bifold (Has Bottom Matrix)
Die #2209	2" x 2" 51mm x 51mm	3"-4.5" 76mm-114mm	Single/Bifold (Has Bottom Matrix)
Die #2216	2" x 3.5" 51mm x 89mm	4.5"-7.1" 114mm-180mm	Single Same as standard die 2225
Die #2171	2.25" x .5" 57mm x 13mm	3.8"-7.1" 96mm-180mm	Single Same as standard die 2156
Die #2068	2.25" x 1" 57mm x 25mm	1.6"-3.6" 41mm-91mm	Single Same as standard die 1834

Die #	Dimensions	Circumference Range	Notes
Die #2077	2.25" x 1" 57mm x 25mm	2.5"-4.5" 64mm-114mm	Single
Die #2218	2.25" x 1.25" 57mm x 32mm	2.6"-4.2" 66mm-107mm	Single
Die #1908	2.25" x 1.25" 57mm x 32mm	2.3"-4.9" 58mm-124mm	Single Same as standard die 1841
Die #2351	2.25" x 1.5" 57mm x 38mm	3.2"-5.4" 81mm-137mm	Single/Bifold Same as standard die 2009
Die #2003	2.25" x 1.5" 57mm x 38mm	3.1"-7.1" 79mm-180mm	Single
Die #1842	2.25" x 1.5" 57mm x 38mm	4.2"-8" 107mm-203mm	Single
Die #1856	2.25" x 1.5" 57mm x 38mm	5.8"-9.9" 147mm-251mm	Single
Die #2058	2.25" x 1.75" 57mm x 44mm	5"-8.1" 127mm-206mm	Single
Die #2186	2.25" x 1.875" 57mm x 48mm	3"-4.8" 76mm-122mm	Single/Bifold

NON-MATRIX

SPOOLED

P.O.D. SPOOLED

TOTE

MATRIX

MULTIPANEL

NF SPOOLED

TAB

DUO

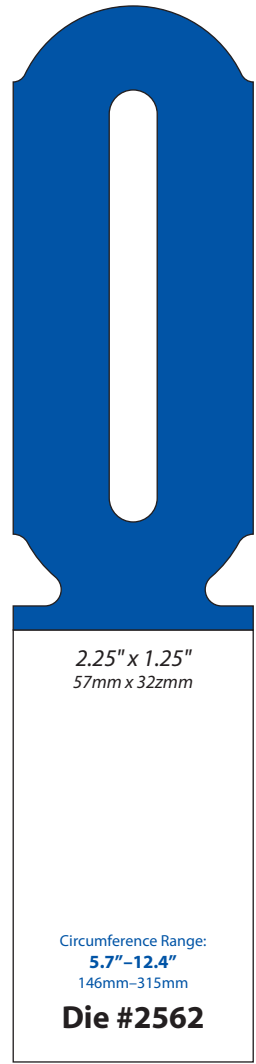

Single

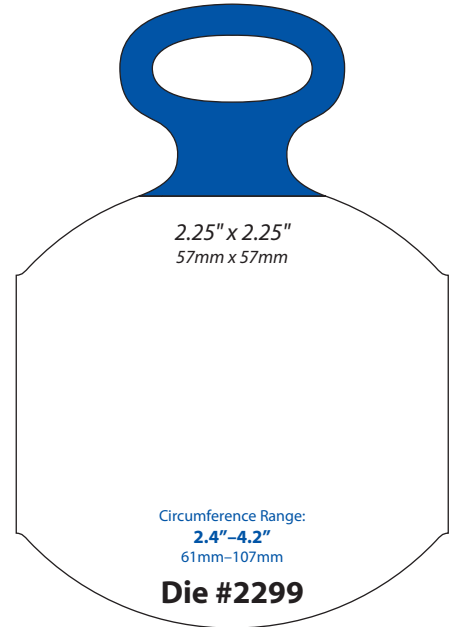

Single  
(Has Bottom Matrix)



Single/Bifold  
(Has Bottom Matrix)

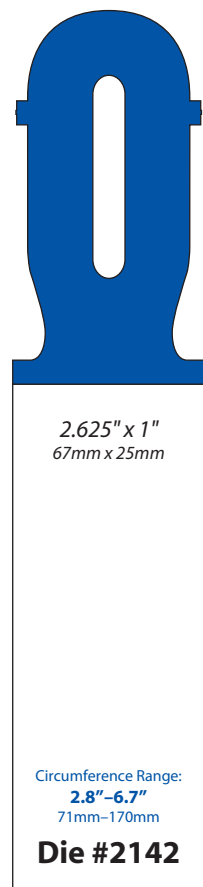

Single

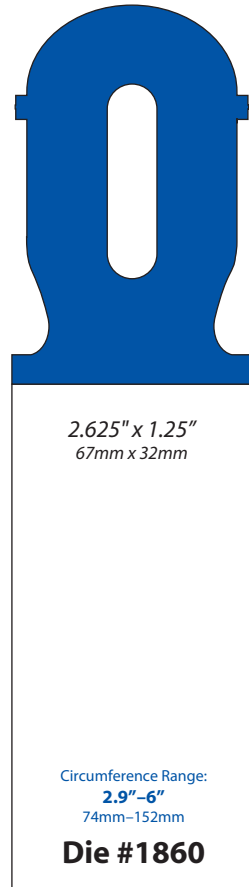

Single

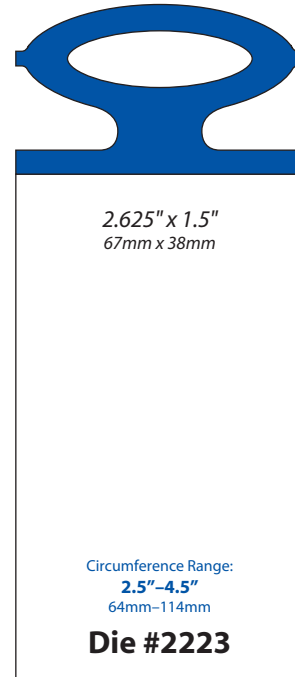

Single

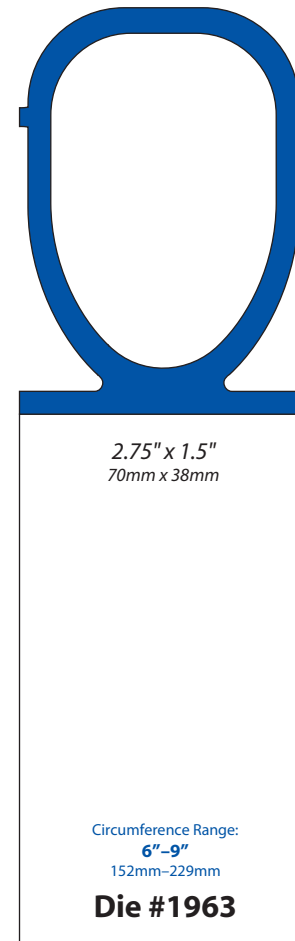

Single

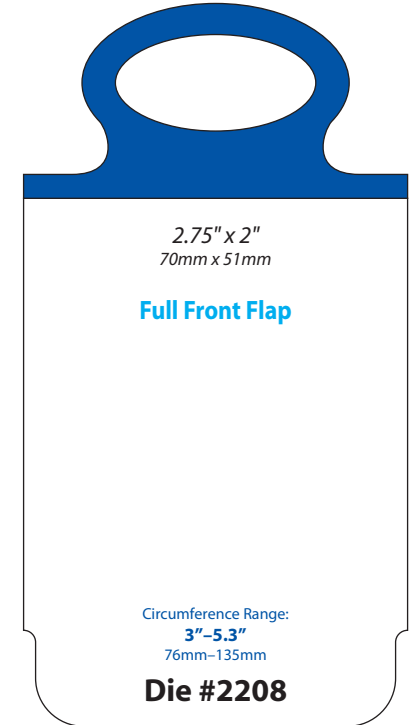

Single/Bifold  
(Has Bottom Matrix)

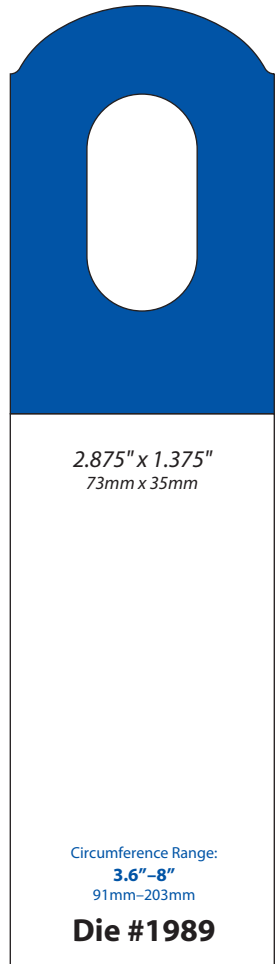

Single  
Same as standard die 1854

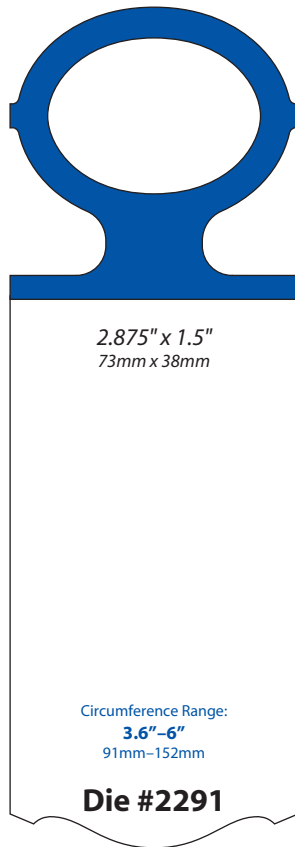

Single

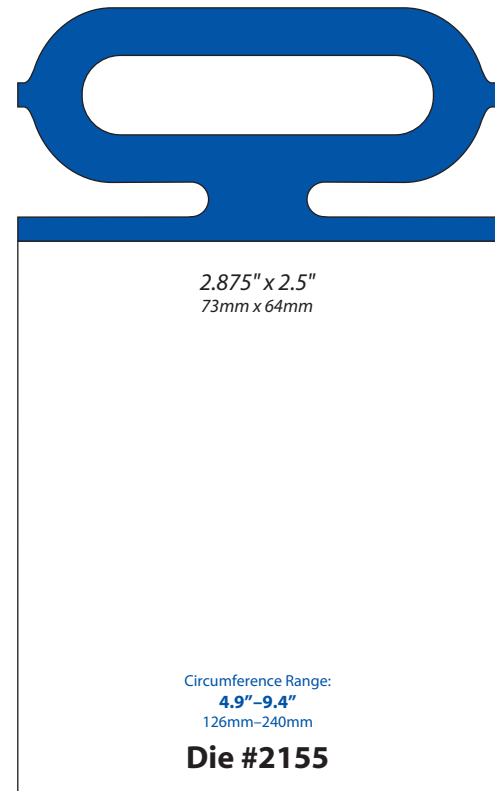

Single

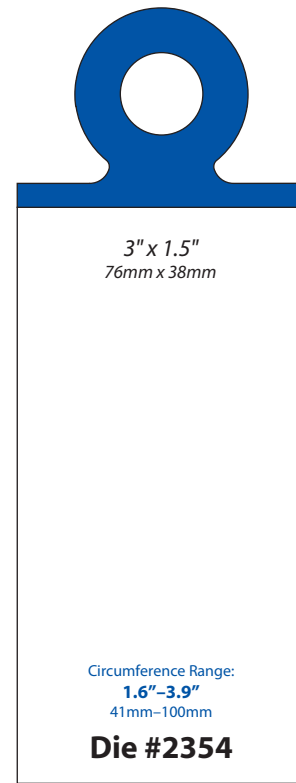

Single

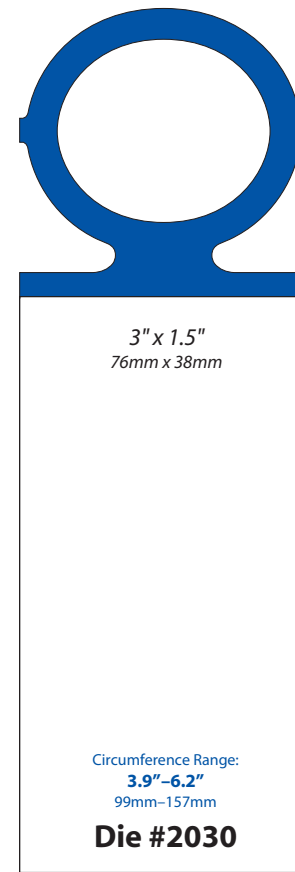

Single/Bifold

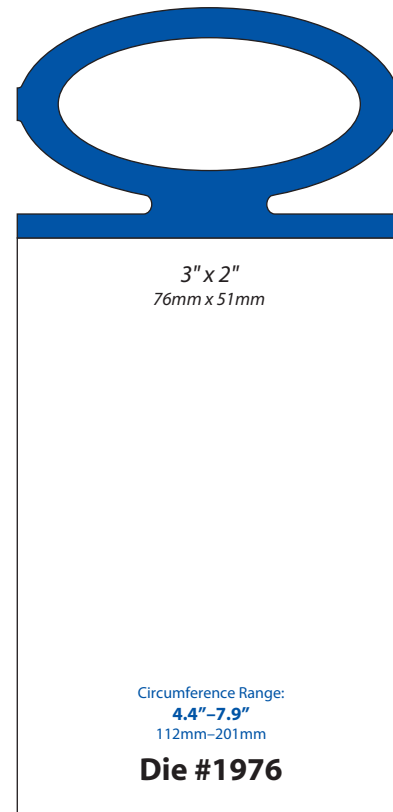

Single/Bifold

- 1860
- 1963
- 1976
- 1989
- 2030
- 2142
- 2155
- 2208
- 2211
- 2223
- 2291
- 2299
- 2354
- 2562

NON-MATRIX

SPOOLED

P.O.D. SPOOLED

TOTE

MATRIX

MULTIPANEL

NF SPOOLED

TAB

DUO

- 1861
- 1891
- 1945
- 1979
- 2296
- 2352

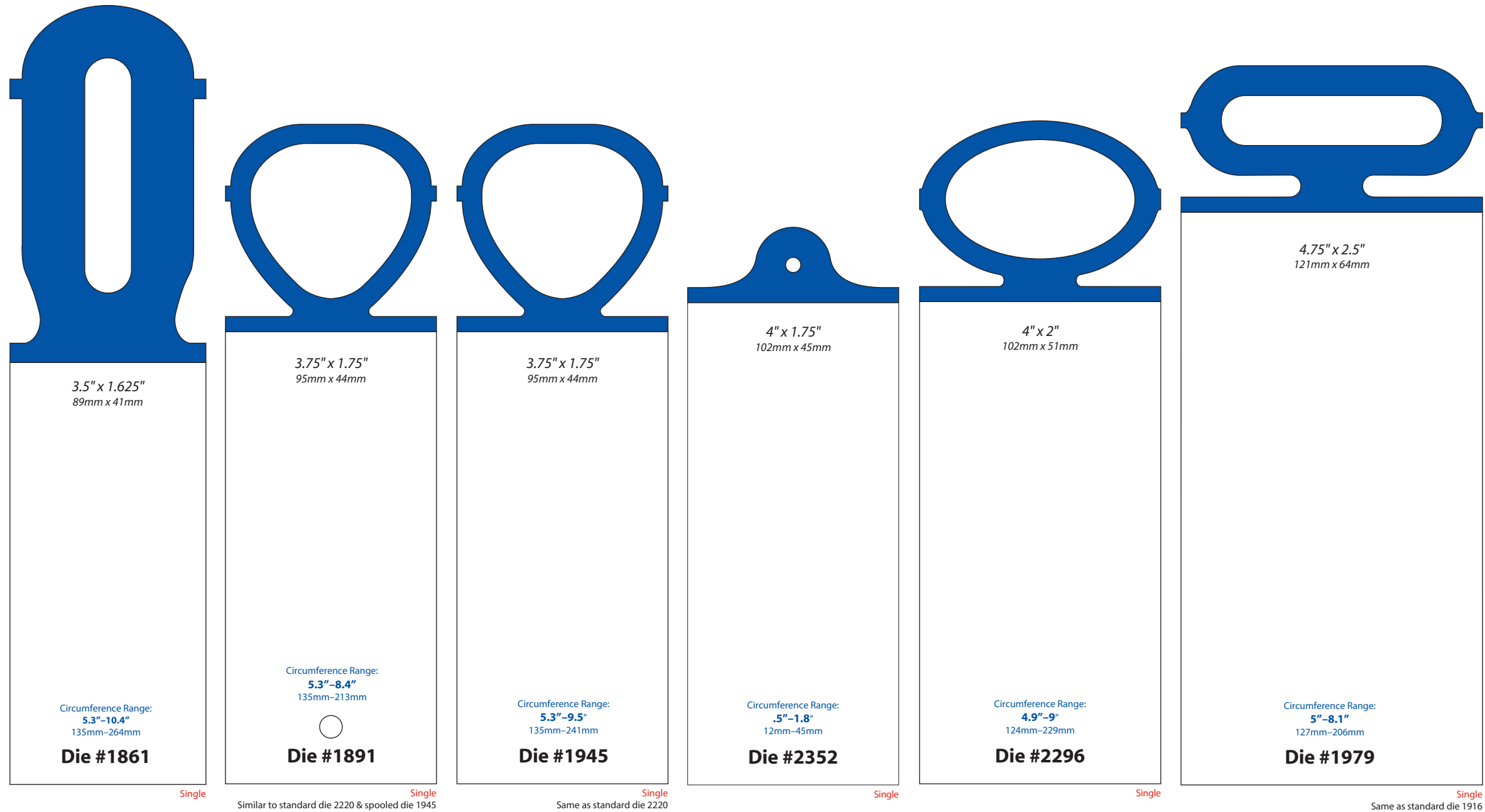

NON-MATRIX

SPOOLED

P.O.D. SPOOLED

TOTE

MATRIX

MULTIPANEL

NF SPOOLED

TAB

DUO



- 1842
- 1856
- 1860
- 1894
- 1908
- 1963
- 1989
- 2003
- 2058
- 2068
- 2077
- 2142
- 2155
- 2218
- 2223

**Print on Demand**  
Spooled tags that work in conjunction with thermal transfer printers

- NON-MATRIX
- SPOOLED
- P.O.D. SPOOLED**
- TOTE
- MATRIX
- MULTIPANEL
- NF SPOOLED
- TAB
- DUO

**ElastiTag**  
BY BEDFORD

Updated: 10/04/21

Patent: elastitag.com/patents

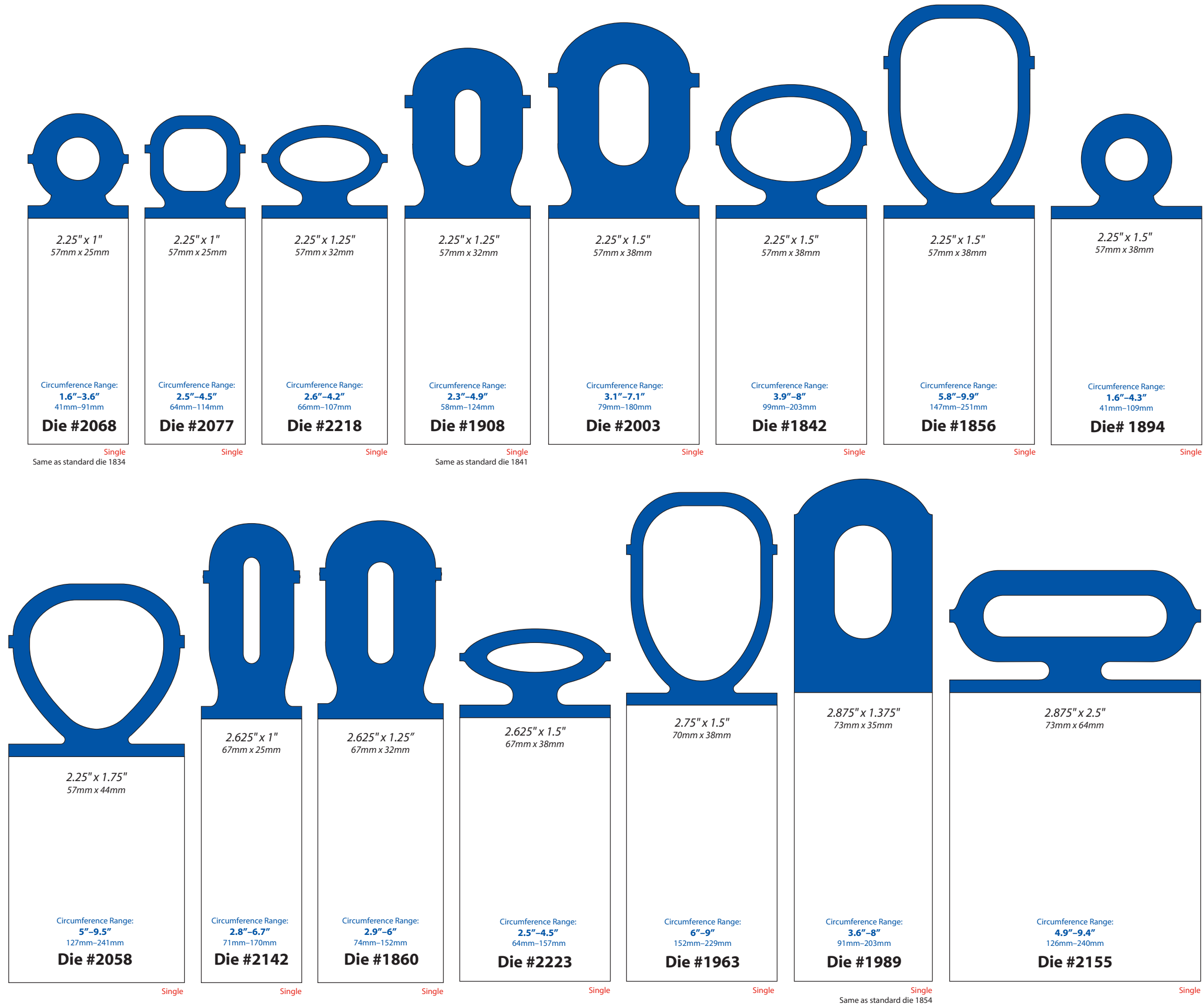

- 1945
- 1976
- 2030
- 2352
- 2354

**Print on Demand**  
Spooled tags that work in conjunction with thermal transfer printers

**NON-MATRIX SPOOLED**

**P.O.D. SPOOLED**

**TOTE**

**MATRIX**

**MULTIPANEL**

**NF SPOOLED**

**TAB**

**DUO**

**ElastiTag**  
BY BEDFORD

Updated: 10/04/21

Patent: elastitag.com/patents

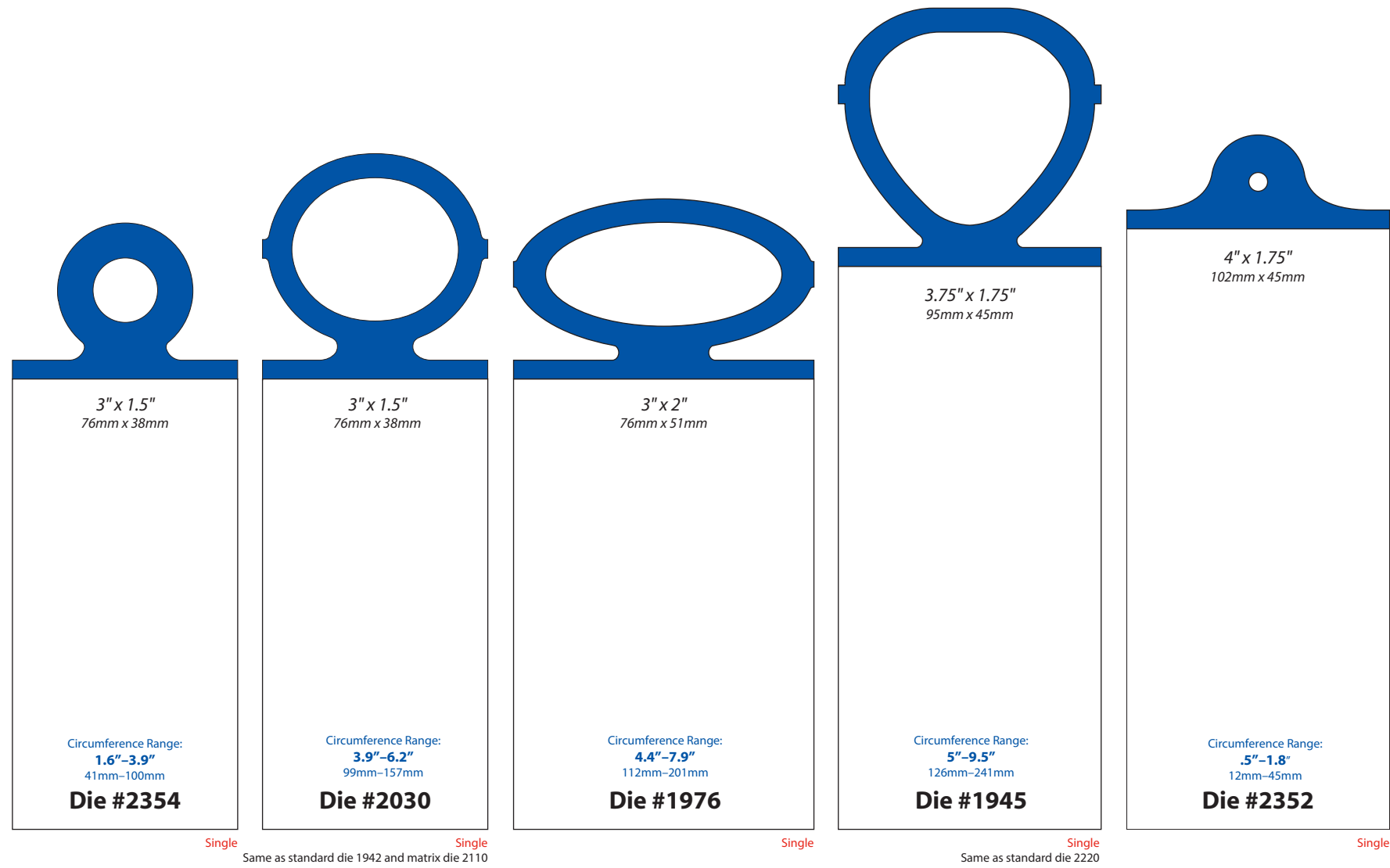

1927  
1969  
1985

FOLDED FRONT VIEW



FOLDED FRONT VIEW



FOLDED FRONT VIEW

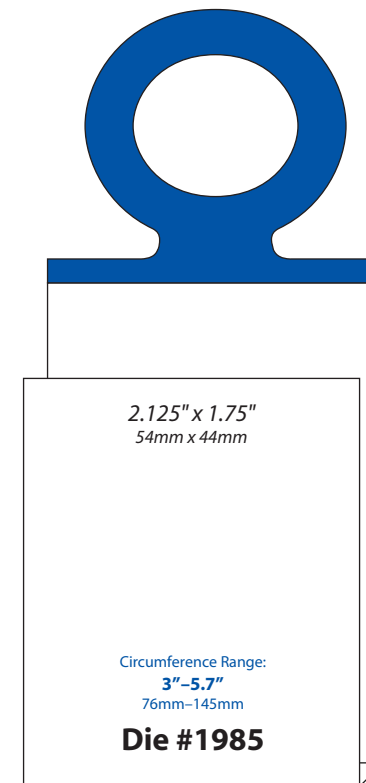

INSIDE VIEW

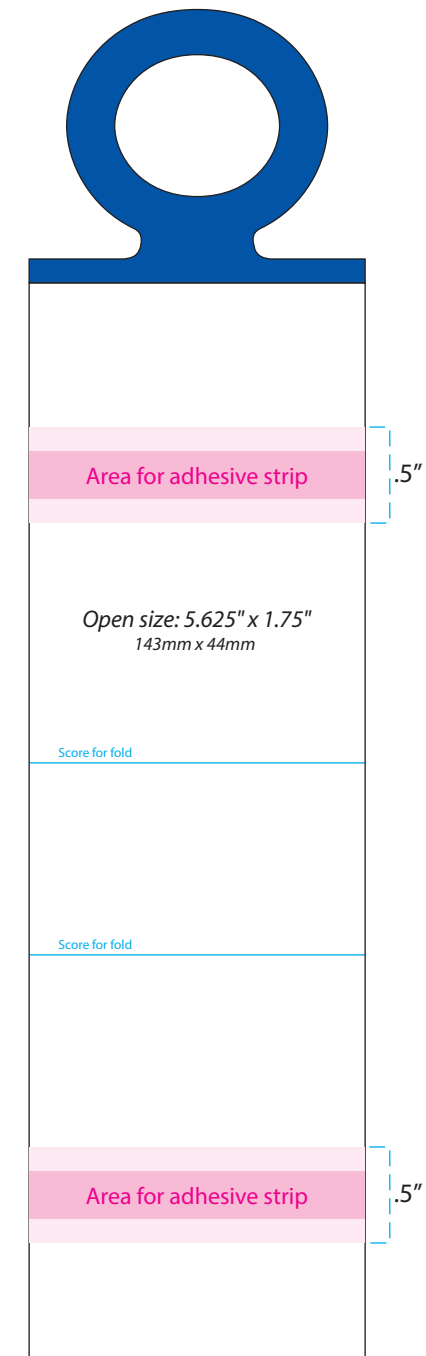

INSIDE VIEW

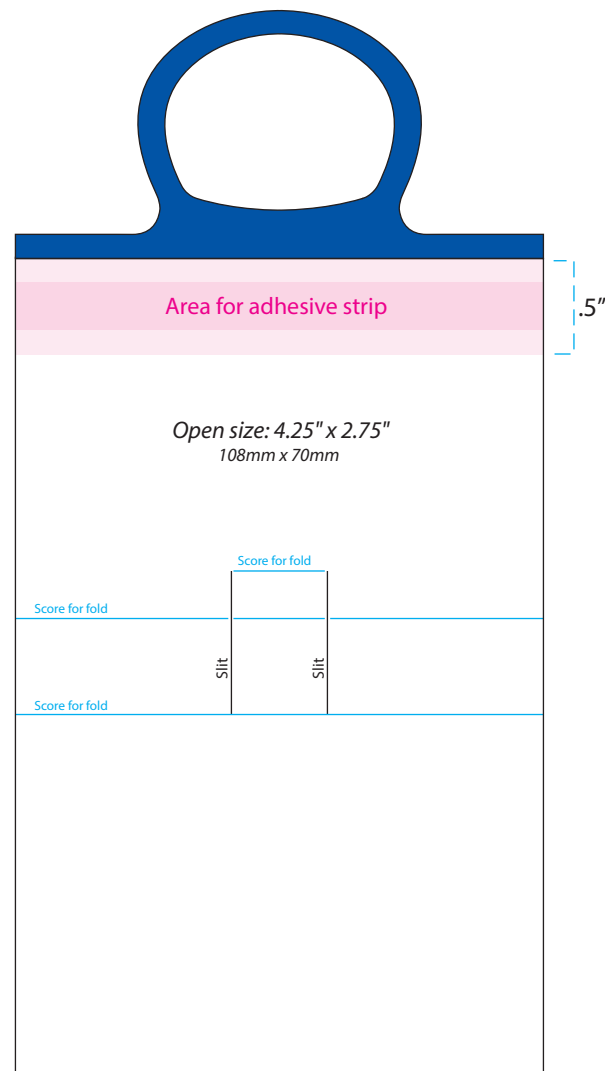

INSIDE VIEW

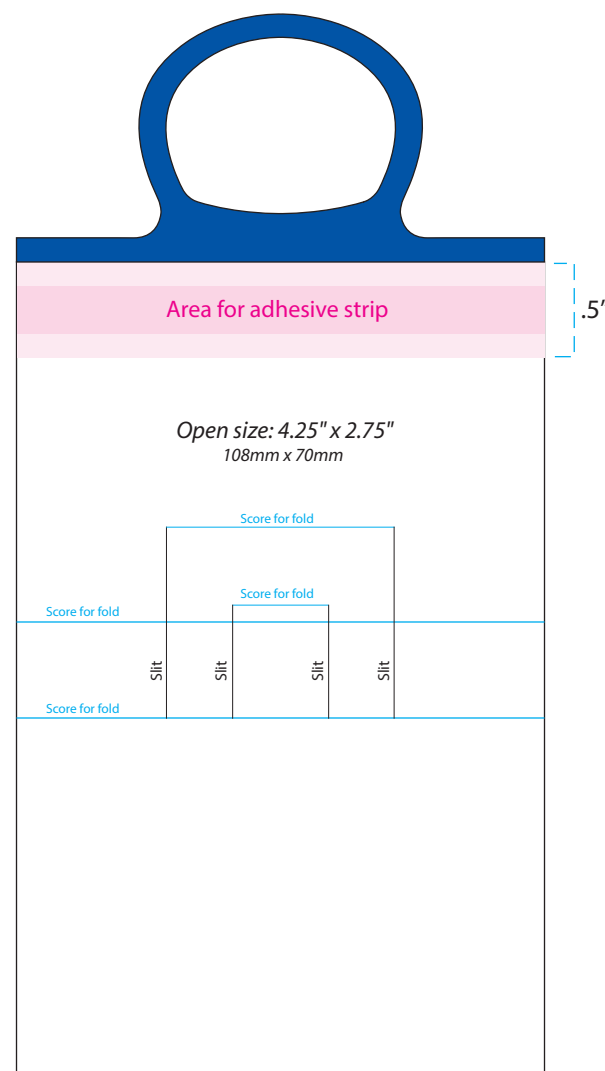

- NON-MATRIX
- SPOOLED
- P.O.D. SPOOLED
- TOTE
- MATRIX
- MULTIPANEL
- NF SPOOLED
- TAB
- DUO

- 1954
- 1996
- 2079
- 2159
- 2203
- 2204
- 2363
- 2494
- 2500
- 2547
- 2576
- 2579
- 2580
- 2584
- 2593
- 2632
- 2682

Circumference Range:  
**2.7"–4.5"**  
69mm–114mm

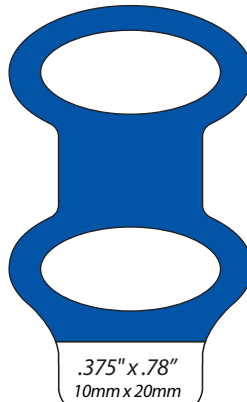

**.375" x .78"**  
10mm x 20mm

Tag with a Matrix  
Allows background images  
or patterns to bleed

**Die #2500**  
Single

Circumference Range:  
**1.9"–2.4"**  
48mm–61mm



**.75" x 1"**  
19mm x 25mm

Tag with a Matrix  
Allows background images  
or patterns to bleed

**Die #2547**  
Single/Bifold



**1.125" x .3"**  
29mm x 8mm

**Full Front Flap**

Tag with a Matrix  
Allows background images  
or patterns to bleed

Circumference Range:  
**2.2"–3.5"**  
56mm–89mm

**Die #2593**  
Single/Bifold

Circumference Range:  
**.9"–3.3"**  
23mm–83mm

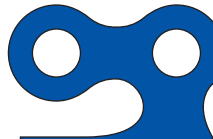

**.75" x 1"**  
19mm x 25mm

Tag with a Matrix  
Allows background images  
or patterns to bleed

**Die #2079**  
Single



**1.5" x 1.25"**  
38mm x 32mm

Uppers Circumference Range:  
**1.4"–3"**  
36mm–76mm

Lower Circumference Range:  
**2.9"–5"**  
72mm–127mm

**Die #2579**  
Single/Bifold

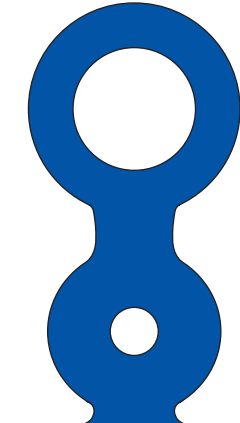

**1.5" x 1.25"**  
38mm x 32mm

Upper Circumference Range:  
**2.4"–4.2"**  
61mm–107mm

Lower Circumference Range:  
**.9"–2.2"**  
24mm–56mm

**Die #2580**  
Single

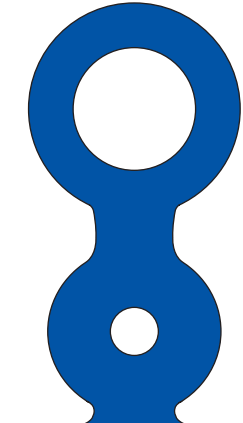

**1.5" x 1.25"**  
38mm x 32mm

**Full Front Flap**

Tag with a Matrix  
Allows background images  
or patterns to bleed

Upper Circumference Range:  
**2.4"–4.2"**  
61mm–107mm

Lower Circumference Range:  
**.9"–2.2"**  
24mm–56mm

**Die #2584**  
Single/Bifold

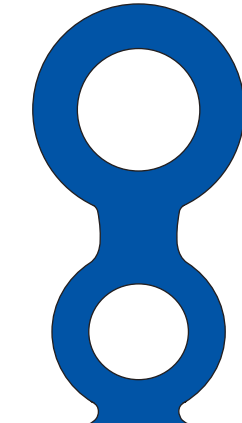

**1.5" x 1.25"**  
38mm x 32mm

Upper Circumference Range:  
**2.4"–4.2"**  
61mm–107mm

Lower Circumference Range:  
**1.9"–3.4"**  
48mm–86mm

**Die #1996**  
Single

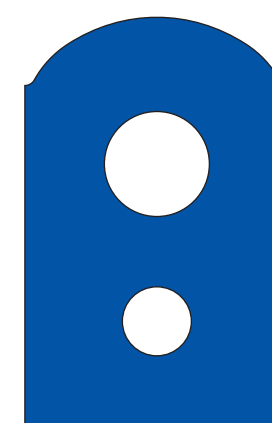

**1.625" x 1.375"**  
41mm x 35mm

Upper Circumference Range:  
**2.1"–6.2"**  
53mm–157mm

Lower Circumference Range:  
**1.4"–4.2"**  
35mm–107mm

**Die #2159**  
Single

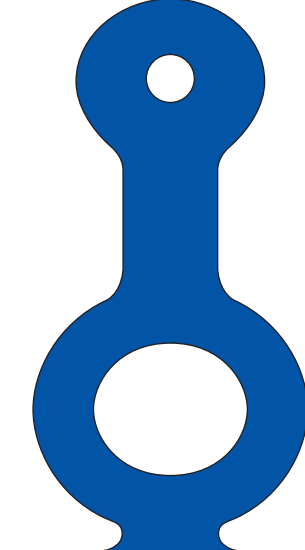

**1.75" x 1.5"**  
45mm x 38mm

Upper Circumference Range:  
**.9"–3"**  
24mm–76mm

Lower Circumference Range:  
**2.8"–4.4"**  
72mm–110mm

**Die #2363**  
Single

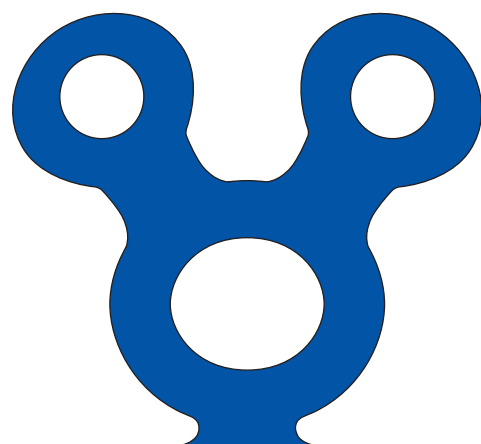

**1.75" x 2.5"**  
45mm x 64mm

**Full Front Flap**

Upper Circumference Range:  
**1.7"–3.6"**  
43mm–91mm

Lower Circumference Range:  
**2.8"–5.6"**  
71mm–142mm

**Die #2632**  
Single/Bifold

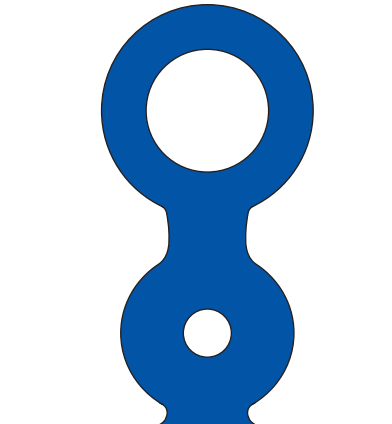

**2" x 2"**  
51mm x 51mm

**Full Front Flap**

Upper Circumference Range:  
**2.5"–4.2"**  
64mm–107mm

Lower Circumference Range:  
**.9"–2.2"**  
23mm–56mm

**Die #2682**  
Single/Bifold

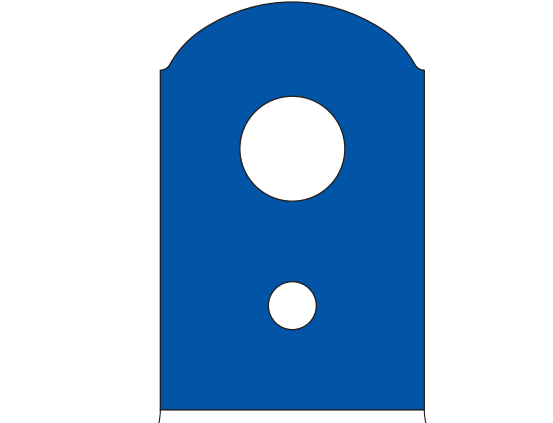

**2.375" x 2.875"**  
60mm x 73mm

**Full Front Flap**

Tag with a Matrix  
Allows background images  
or patterns to bleed

Upper Circumference Range:  
**2.1"–4.5"**  
52mm–115mm

Lower Circumference Range:  
**.9"–1"**  
23mm–25mm

**Die #2576**  
Single/Bifold

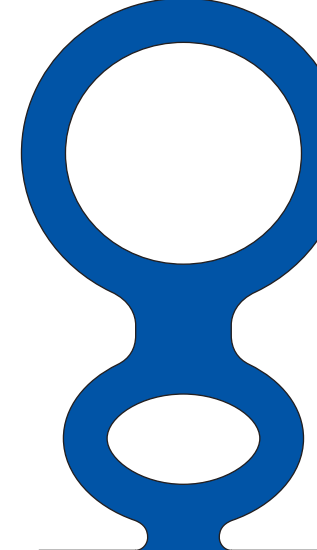

**2.5" x 1.5"**  
64mm x 38mm

**Full Front Flap**

Tag with a Matrix  
Allows background images  
or patterns to bleed

Upper Circumference Range:  
**4.5"–7.8"**  
114mm–198mm

Lower Circumference Range:  
**2.4"–4.6"**  
61mm–117mm

**Die #2494**  
Single/Bifold

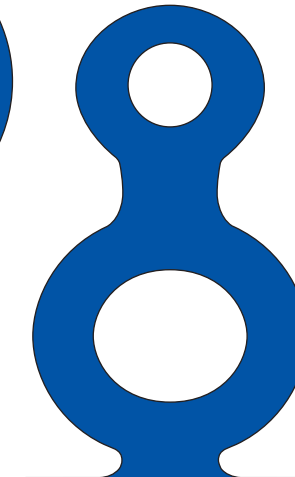

**2.5" x 1.5"**  
64mm x 38mm

Upper Circumference Range:  
**1.7"–4.4"**  
43mm–112mm

Lower Circumference Range:  
**2.8"–6.9"**  
71mm–175mm

**Die #2203**  
Single/Bifold

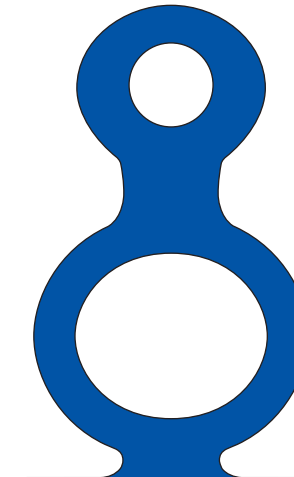

**2.5" x 1.5"**  
64mm x 38mm

Upper Circumference Range:  
**1.7"–4"**  
43mm–102mm

Lower Circumference Range:  
**3.6"–6.9"**  
89mm–175mm

**Die #1954**  
Single/Bifold

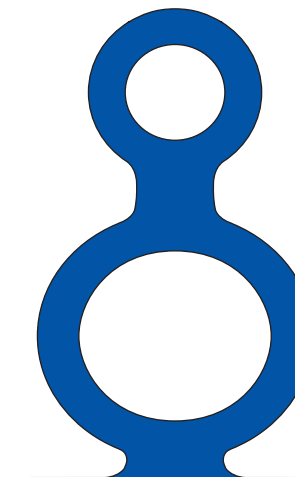

**2.5" x 1.5"**  
64mm x 38mm

Upper Circumference Range:  
**1.9"–4.6"**  
48mm–117mm

Lower Circumference Range:  
**3.6"–6.8"**  
91mm–173mm

**Die #2204**  
Single

- NON-MATRIX
- SPOOLED
- P.O.D. SPOOLED
- TOTE
- MATRIX
- MULTIPANEL
- NF SPOOLED
- TAB
- DUO

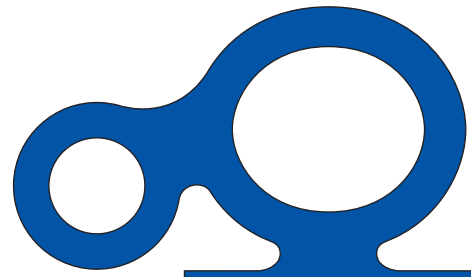

2.5" x 1.5"  
64mm x 38mm

**Full Front Flap**

Tag with a Matrix  
Allows background images  
or patterns to bleed

Left Circumference Range:  
**1.8"-3.7"**  
46mm-94mm

Right Circumference Range:  
**3.48"-5.5"**  
88mm-140mm

**Die #2409**

Single/Bifold

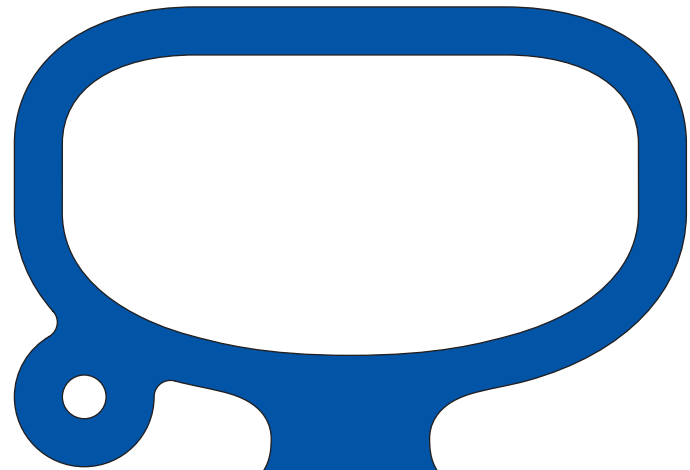

2.5" x 2"  
64mm x 51mm

**Full Front Flap**

Tag with a Matrix  
Allows background images  
or patterns to bleed

Left Circumference Range:  
**.9"-2.3"**  
23mm-58mm

Right Circumference Range:  
**9.5"-16.7"**  
241mm-1424mm

**Die #2707**

Single/Bifold

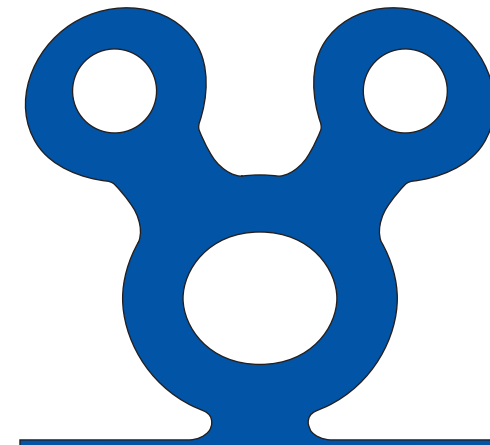

2.5" x 2.5"  
64mm x 64mm

**Full Front Flap**

Tag with a Matrix  
Allows background images  
or patterns to bleed

Upper Circumference Range:  
**1.7"-3.6"**  
42mm-91mm

Lower Circumference Range:  
**2.8"-5.5"**  
72mm-140mm

**Die #2508**

Single/Bifold

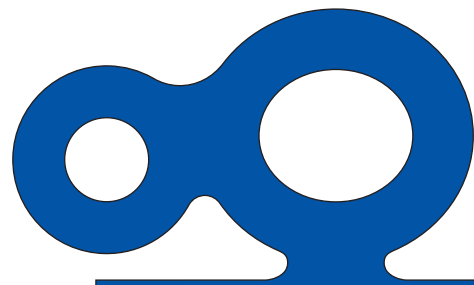

2.5" x 2.5"  
64mm x 64mm

**Full Front Flap**

Tag with a Matrix  
Allows background images  
or patterns to bleed

Left Circumference Range:  
**1.7"-4.4"**  
42mm-111mm

Right Circumference Range:  
**2.8"-6.9"**  
72mm-174mm

**Die #2573**

Single/Bifold

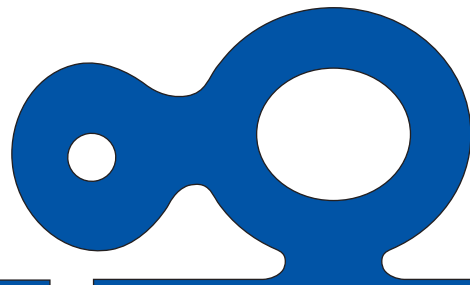

2.5" x 2.5"  
64mm x 64mm

**Full Front Flap**

Tag with a Matrix  
Allows background images  
or patterns to bleed

Left Circumference Range:  
**.9"-2.8"**  
23mm-71mm

Right Circumference Range:  
**2.8"-5.6"**  
71mm-142mm

**Die #2667**

Single/Bifold

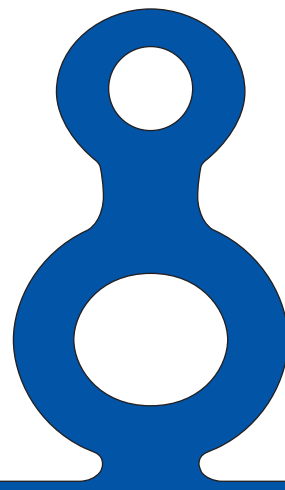

2.5" x 2.5"  
64mm x 64mm

**Full Front Flap**

Tag with a Matrix  
Allows background images  
or patterns to bleed

Upper Circumference Range:  
**1.7"-4.4"**  
42mm-111mm

Lower Circumference Range:  
**2.8"-6.9"**  
72mm-174mm

**Die #2481**

Single/Bifold



2.5" x 2.5"  
64mm x 64mm

**Full Front Flap**

Tag with a Matrix  
Allows background images  
or patterns to bleed

Upper Circumference Range:  
**6"-11.2"**  
152mm-284mm

Lower Circumference Range:  
**4"-6.6"**  
102mm-168mm

**Die #2301**

Single



2.75" x 2.75"  
70mm x 70mm

**Full Front Flap**

Tag with a Matrix  
Allows background images  
or patterns to bleed

Left Circumference Range:  
**3.3"-5.75"**  
84mm-146mm

Right Circumference Range:  
**1.9"-4.18"**  
48mm-106mm

**Die #2365**

Single/Bifold

- 2301
- 2365
- 2409
- 2481
- 2508
- 2573
- 2667
- 2707

- NON-MATRIX
- SPOOLED
- P.O.D. SPOOLED
- TOTE
- MATRIX
- MULTIPANEL
- NF SPOOLED
- TAB
- DUO

1968  
2119  
2437  
2691

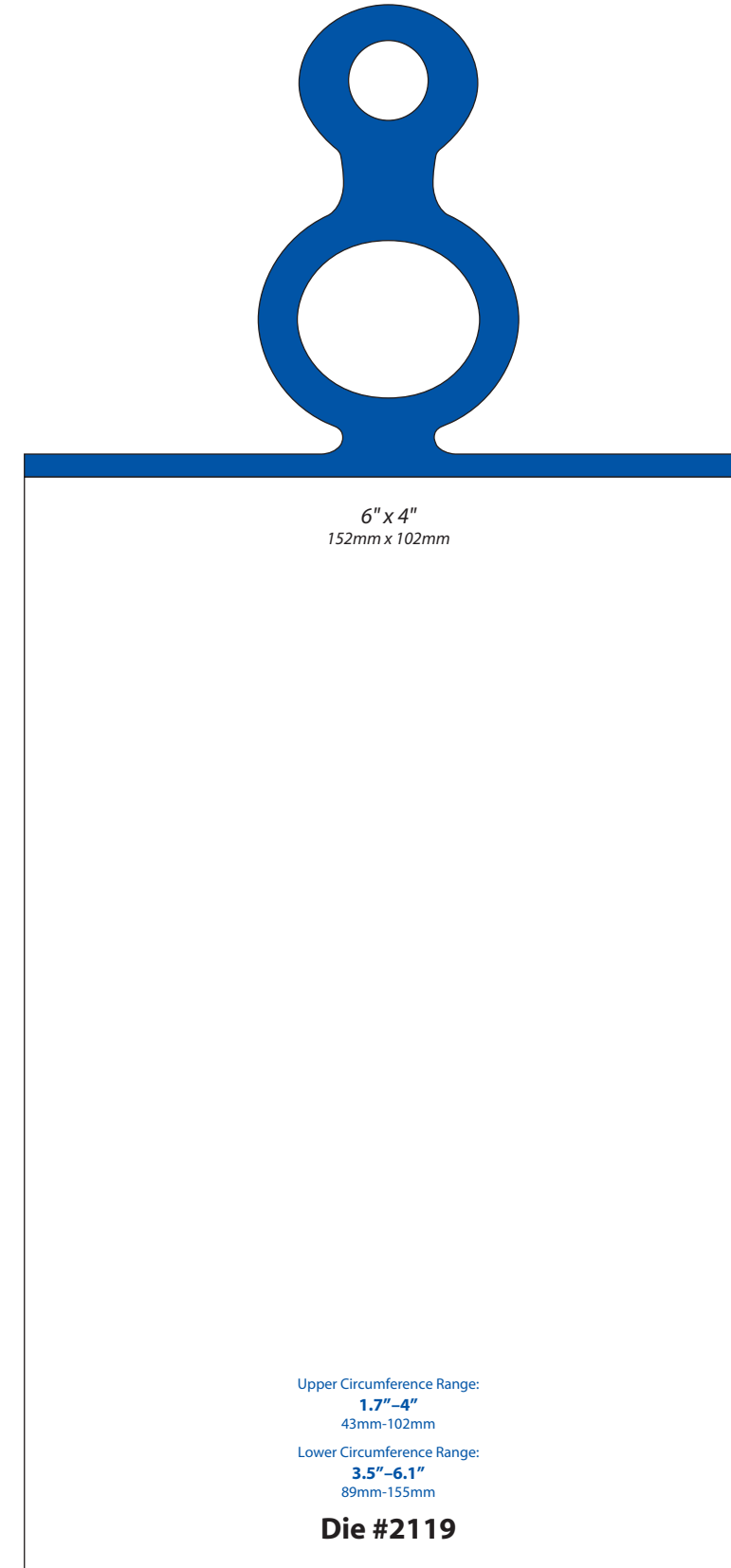
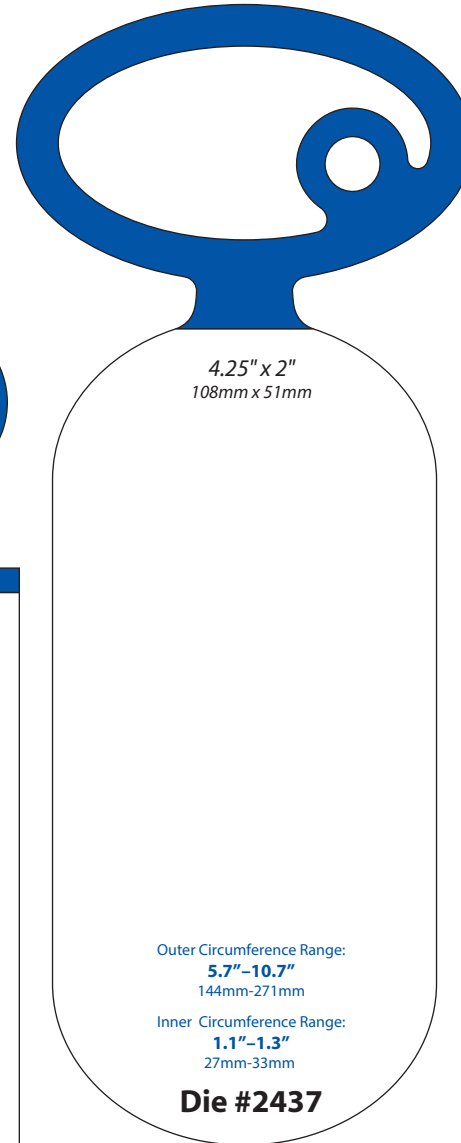
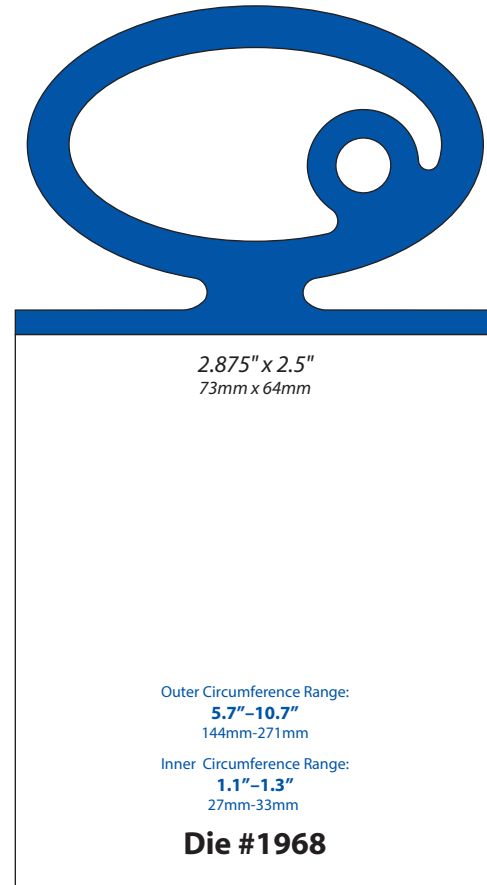
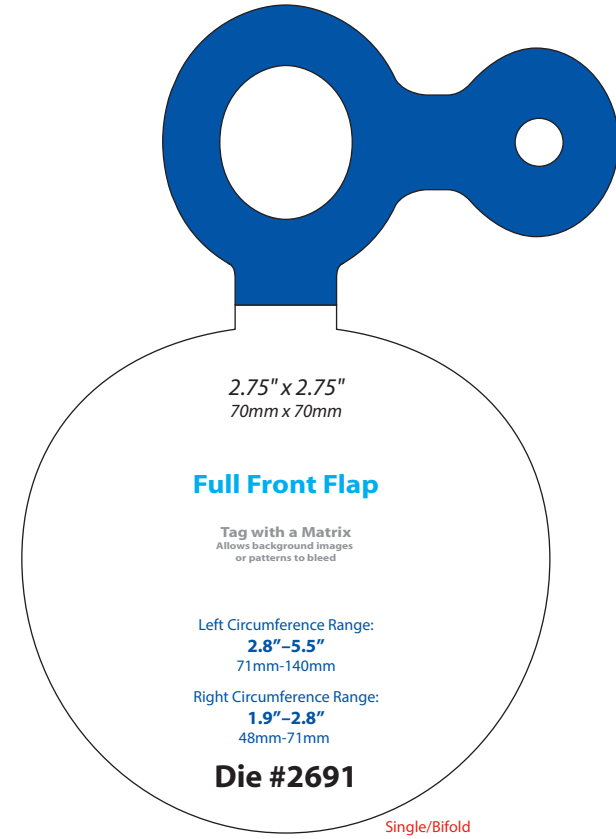

NON-MATRIX  
SPOOLED  
P.O.D. SPOOLED  
TOTE  
MATRIX  
MULTIPANEL  
NF SPOOLED  
TAB  
DUO

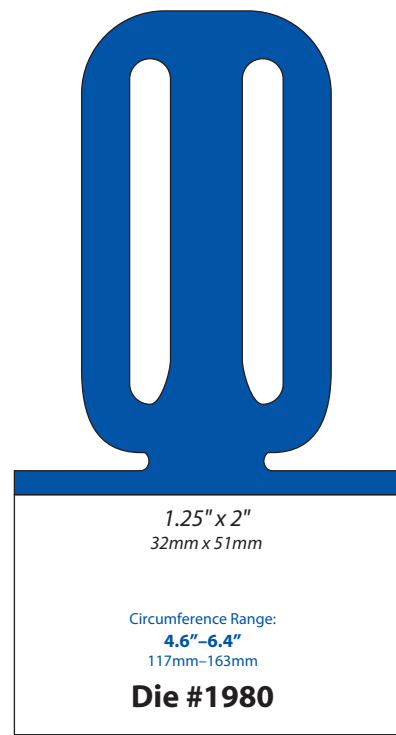

Single/Bifold  
(Has Bottom Matrix)

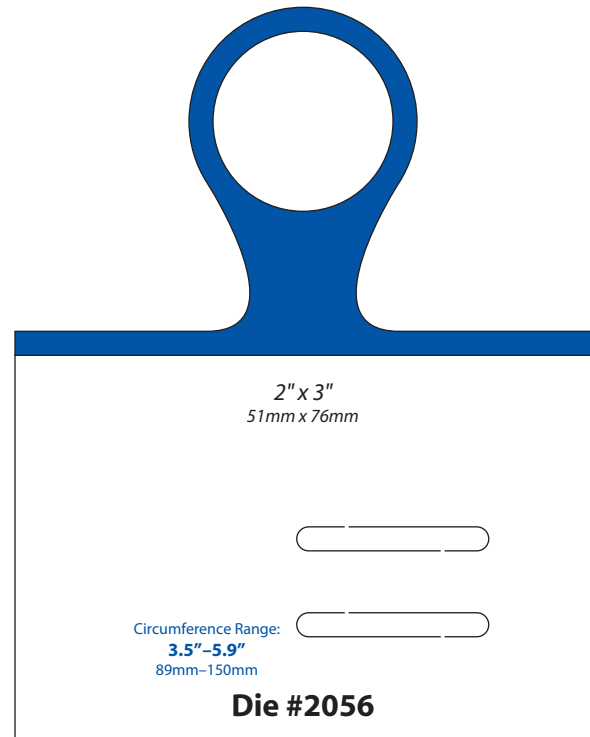

Single



Single



Single

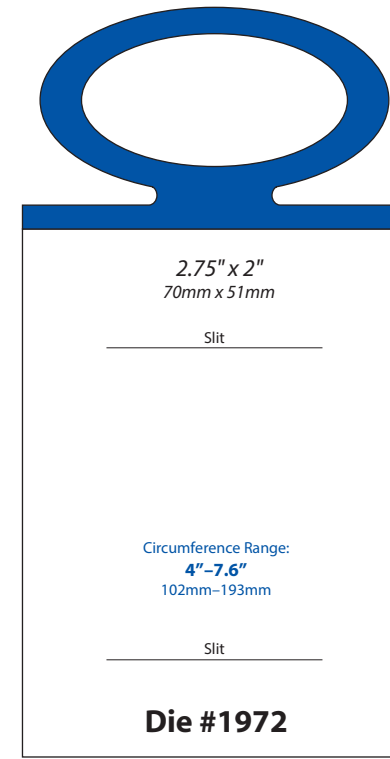

Single

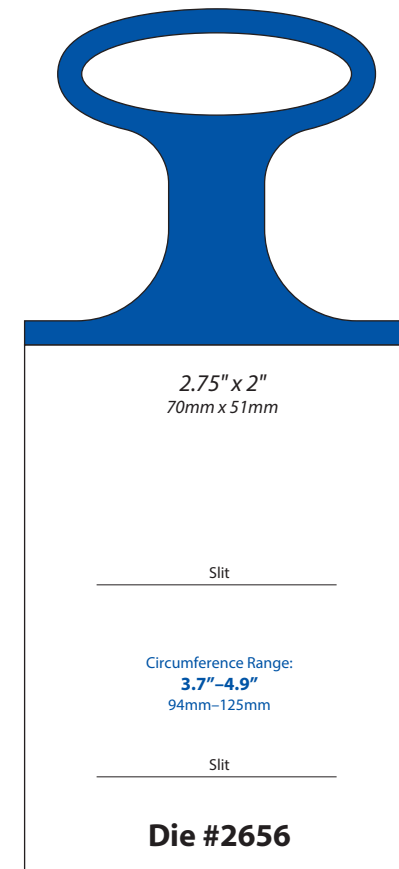

Single

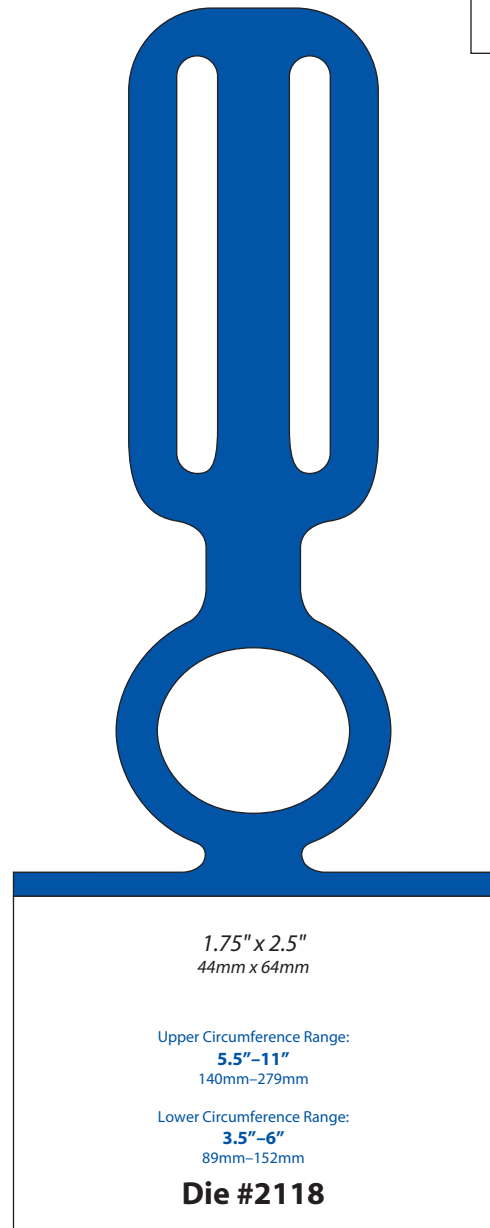

Bifold

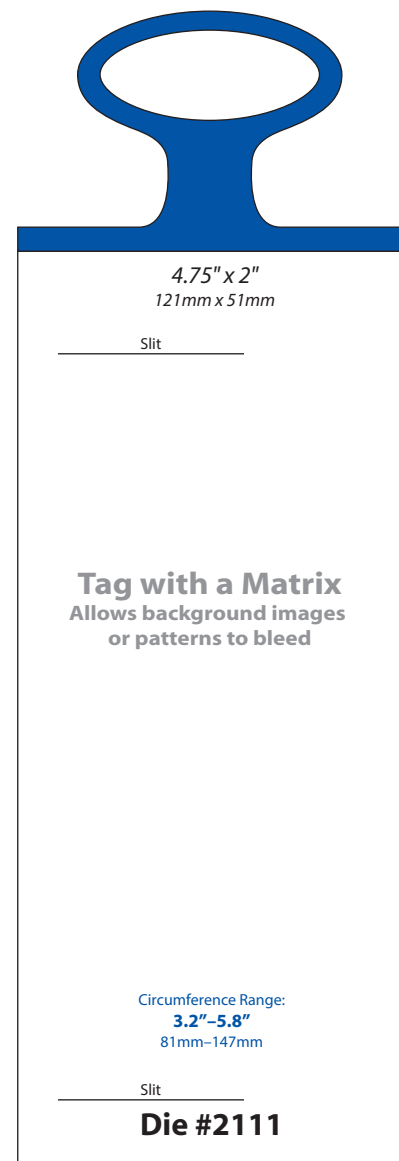

Single

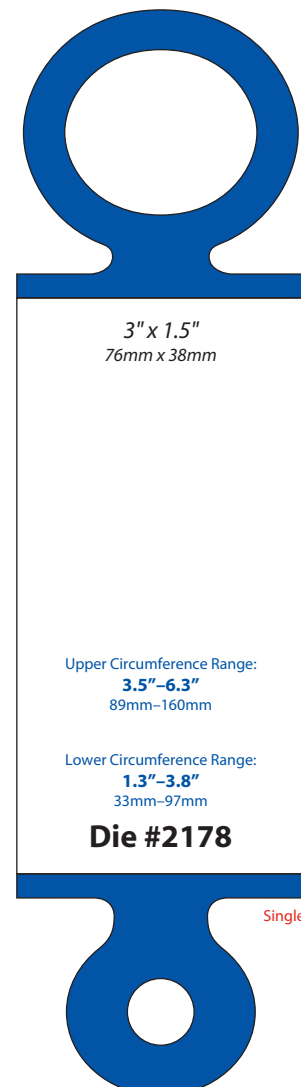

Single

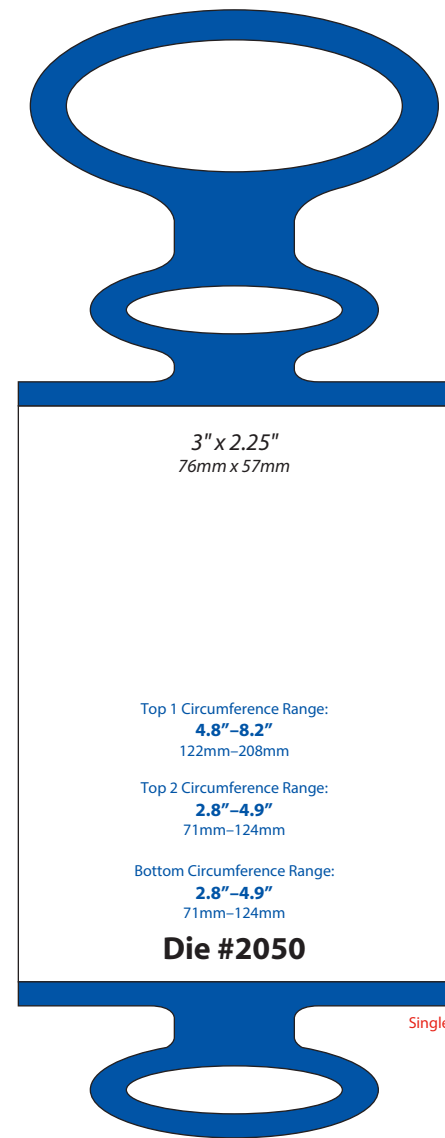

Single



Single/Bifold

- 1972
- 1980
- 2050
- 2056
- 2111
- 2118
- 2178
- 2306
- 2382
- 2639
- 2656

NON-MATRIX  
SPOOLED  
P.O.D. SPOOLED

TOTE

MATRIX

MULTIPANEL

NF SPOOLED

TAB

DUO

- 1958
- 1959
- 1960
- 1971
- 1984
- 1987
- 2185
- 2189
- 2195
- 2206
- 2272
- 2277
- 2366
- 2482
- 2507
- 2520
- 2618

Allows background images to bleed

- NON-MATRIX
- SPOOLED
- P.O.D. SPOOLED
- TOTE
- MATRIX**
- MULTIPANEL
- NF SPOOLED
- TAB
- DUO

**ElastiTag**  
BY BEDFORD

Updated: 10/04/21

Patent: elastitag.com/patents

**Die #1958**  
1.25" x 1.25"  
32mm x 32mm  
Circumference Range: 4.7"-8.9"  
119mm-226mm  
Single/Bifold

**Die #2272**  
1.5" x 1"  
38mm x 25mm  
Circumference Range: 4.8"-9.2"  
122mm-234mm  
Single/Bifold

**Die #2206**  
1.0625" x 1.0625"  
27mm x 27mm  
Circumference Range: 1.8"-3.5"  
47mm-90mm  
Single/Bifold

**Die #2482**  
1.0625" x 1.0625"  
27mm x 27mm  
Circumference Range: 2.5"-4"  
64mm-104mm  
Single/Bifold

**Die #2366**  
1.25" x 1.25"  
32mm x 32mm  
Circumference Range: 3"-4.3"  
76mm-109mm  
Single/Bifold

**Die #2195**  
1.5" x 1.75"  
38mm x 44mm  
Circumference Range: 3.2"-5.8"  
81mm-147mm  
Single/Bifold

**Die #1971**  
1.69" x 1.69"  
43mm x 43mm  
Circumference Range: 1.6"-4.3"  
41mm-109mm  
Single/Bifold

**Die #1959**  
1.69" x 1.69"  
43mm x 43mm  
Circumference Range: 4.7"-8.9"  
119mm-226mm  
Single/Bifold

**Die #1960**  
1.69" x 1.69"  
43mm x 43mm  
Circumference Range: 6.4"-11.7"  
163mm-297mm  
Single/Bifold

**Die #1987**  
1.75" x 1.75"  
44mm x 44mm  
Circumference Range: 7.7"-12.4"  
196mm-315mm  
Single/Bifold

**Die #2507**  
1.75" x 1.75"  
44mm x 44mm  
Circumference Range: 0.9"-3.2"  
23mm-81mm  
Single/Bifold

**Die #2618**  
1.8125" x 1.875"  
46mm x 47mm  
Circumference Range: 4"-7.6"  
102mm-193mm  
Single/Bifold

**Die #1984**  
1.82" x 1.875"  
46mm x 47mm  
Circumference Range: 3.2"-5.4"  
81mm-137mm  
Single/Bifold

**Die #2189**  
1.875" x 1.875"  
48mm x 48mm  
Circumference Range: .984"-2.72"  
25mm-69mm  
Single/Bifold

**Die #2520**  
2" x 2"  
51mm x 51mm  
Circumference Range: 2.3"-4.7"  
57mm-119mm  
Single/Bifold

**Die #2185**  
2.125" x 2.125"  
54mm x 54mm  
Circumference Range: 5.9"-10.9"  
150mm-277mm  
Single/Bifold

**Die #2277**  
2.375" x 2.375"  
60mm x 60mm  
Circumference Range: 2.5"-4.9"  
34mm-124mm  
Single/Bifold



- 2054
- 2062
- 2074
- 2125
- 2137
- 2165
- 2289
- 2319
- 2343
- 2353

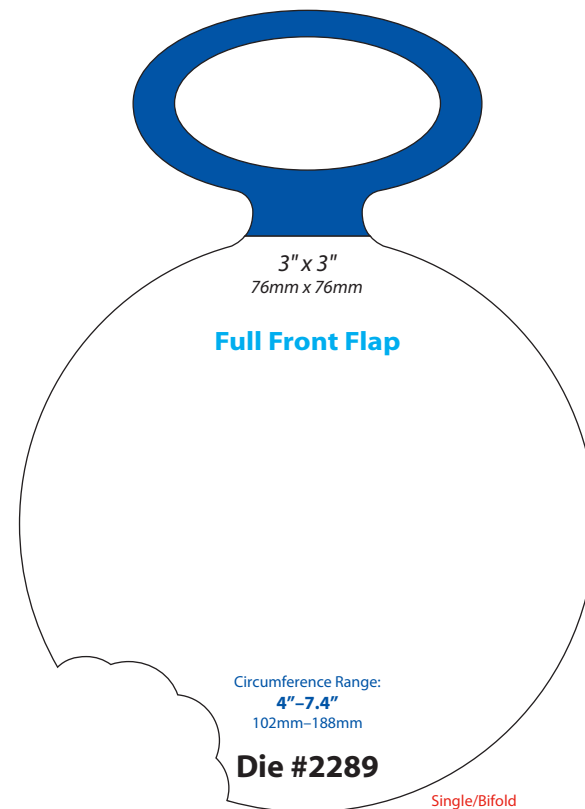
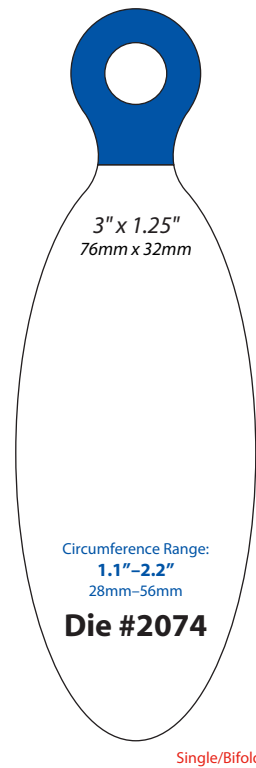
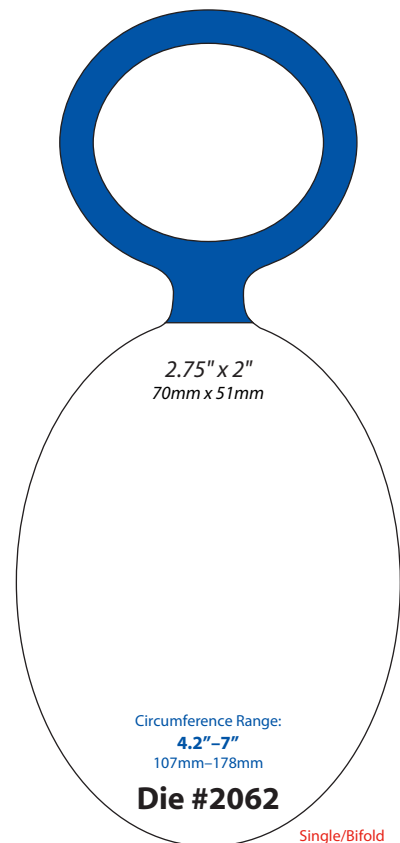
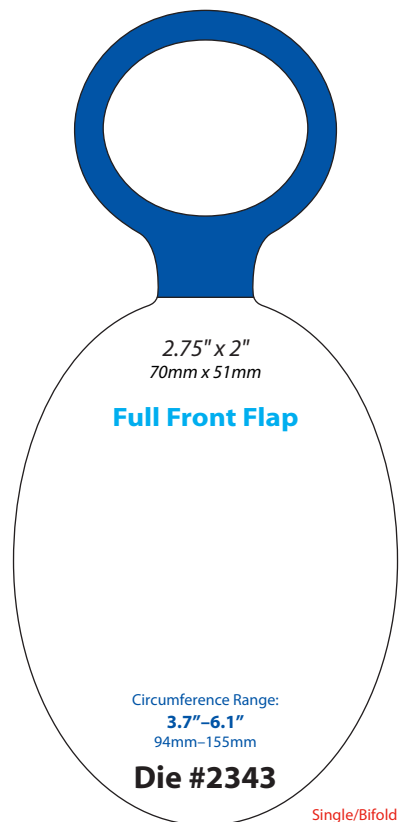
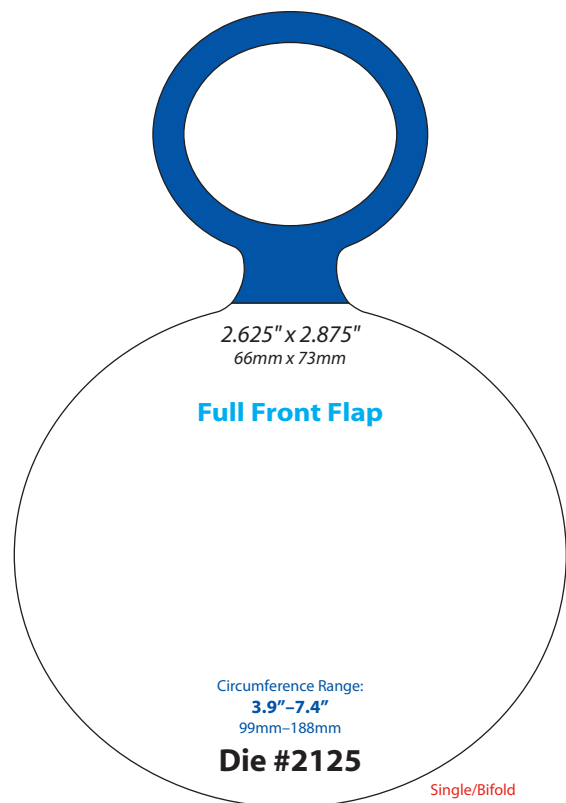
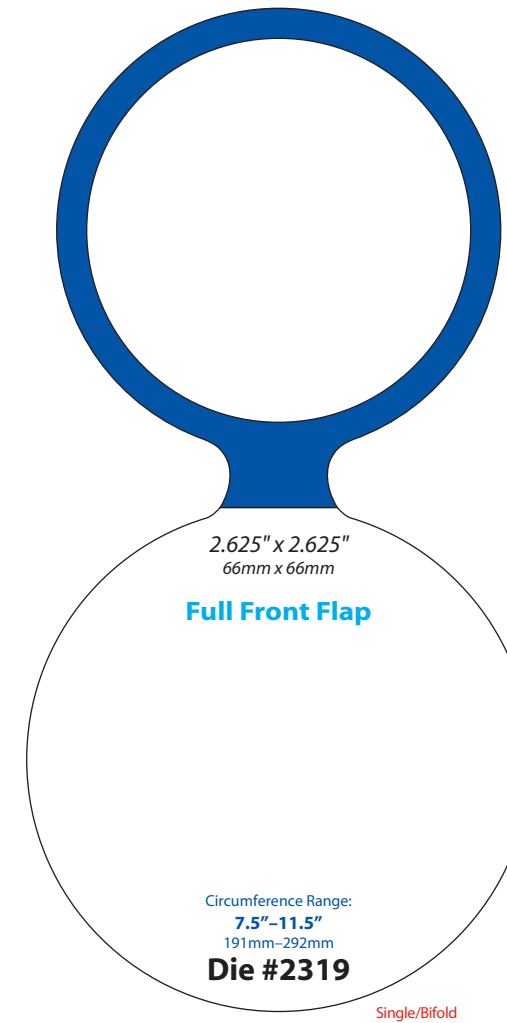
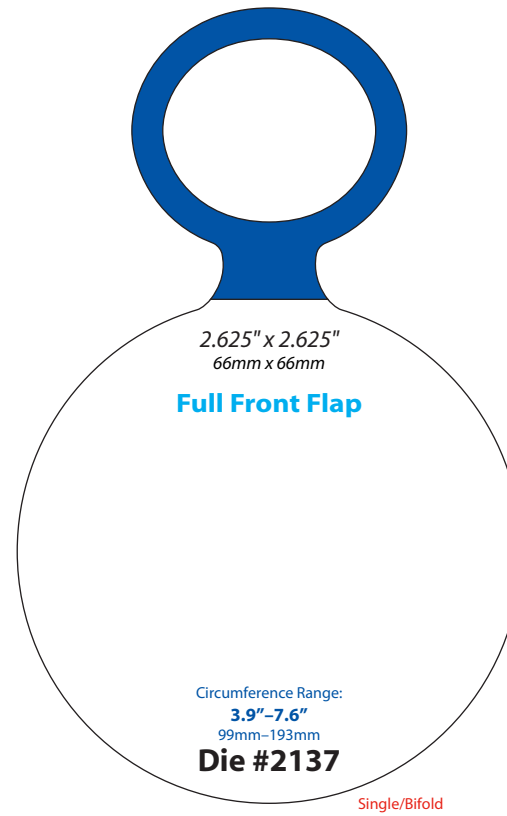
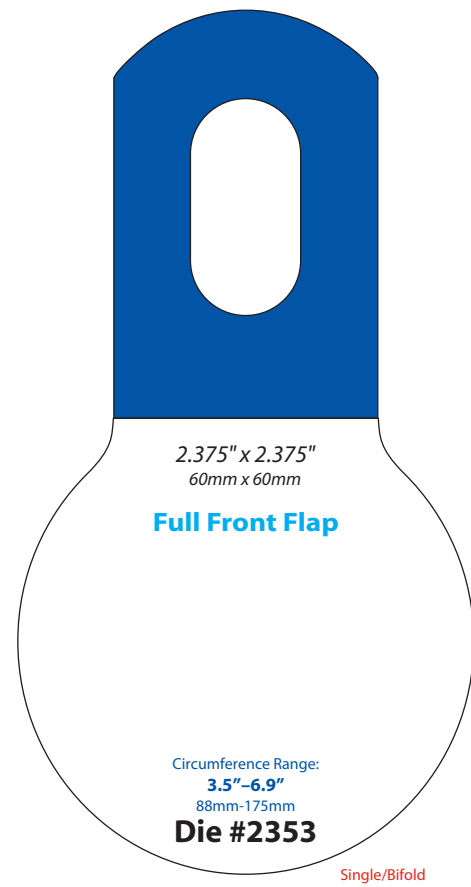
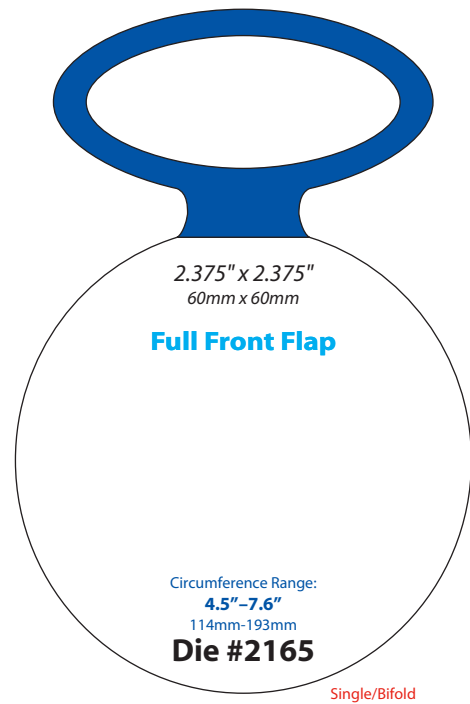
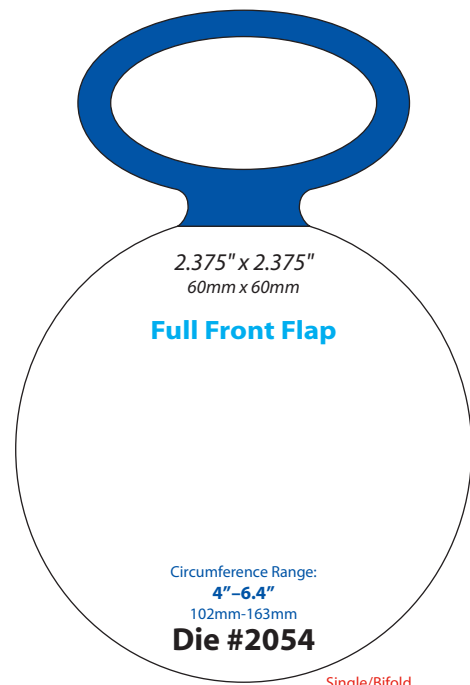

Allows background images to bleed

- NON-MATRIX
- SPOOLED
- P.O.D. SPOOLED
- TOTE

**MATRIX**

- MULTIPANEL
- NF SPOOLED
- TAB
- DUO

2002  
2006  
2253  
2346

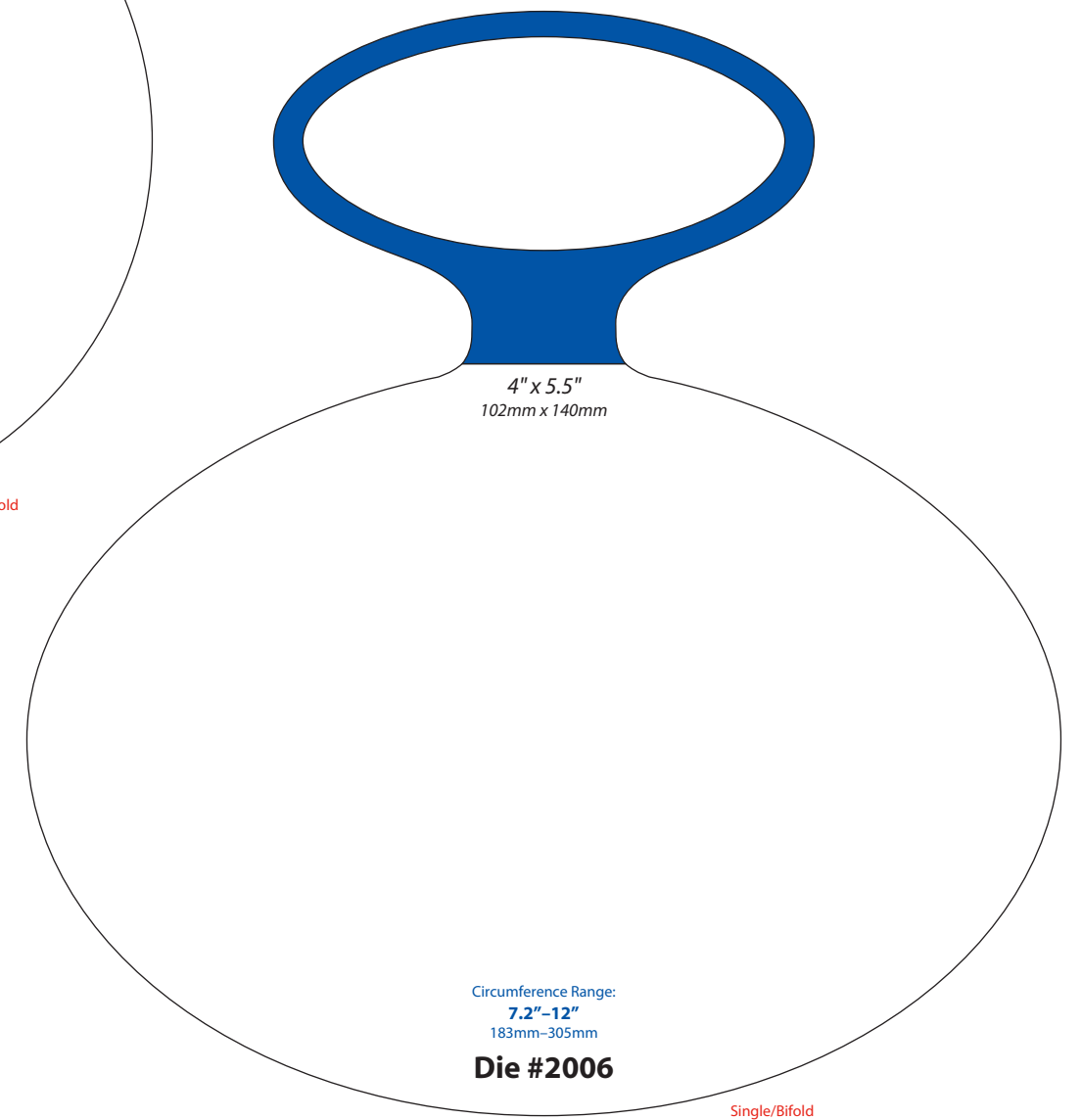
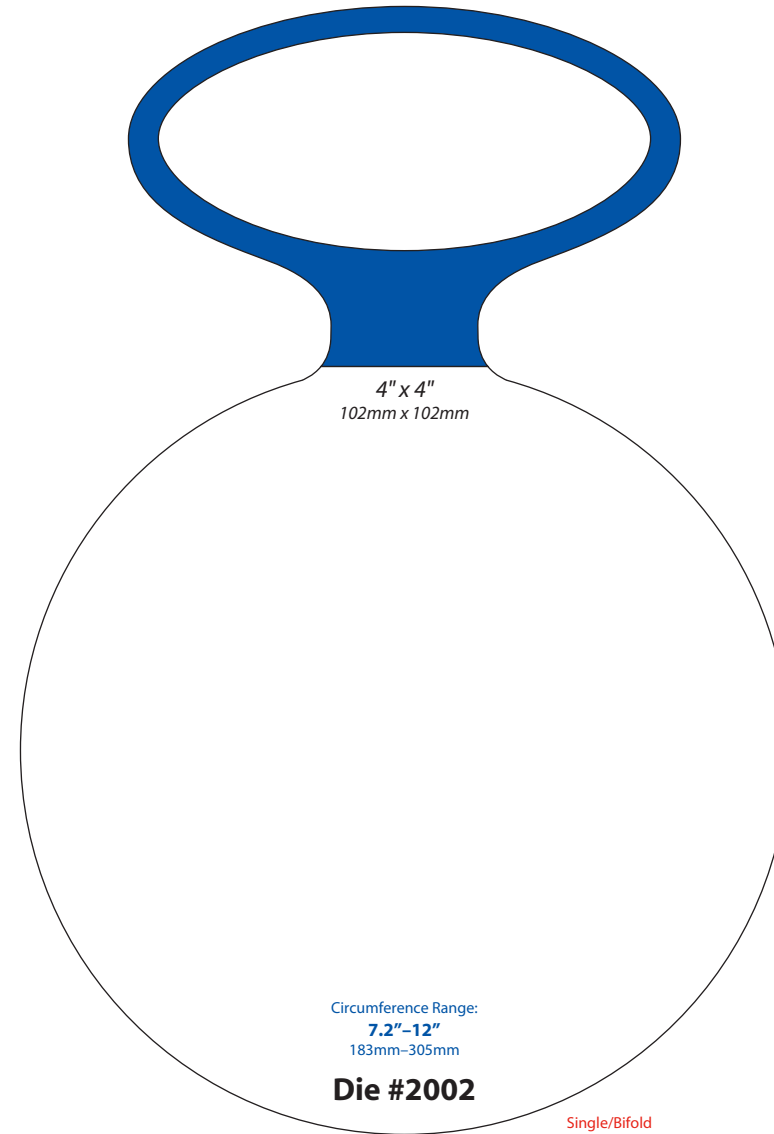
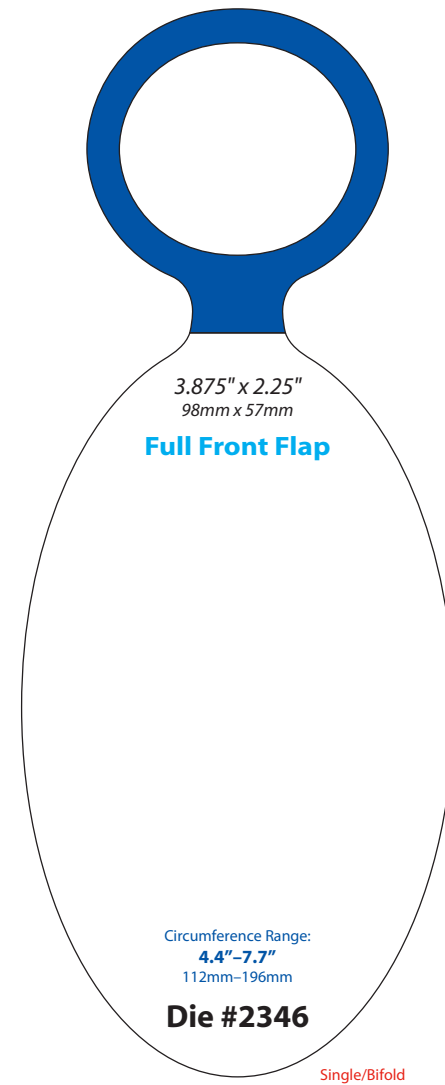
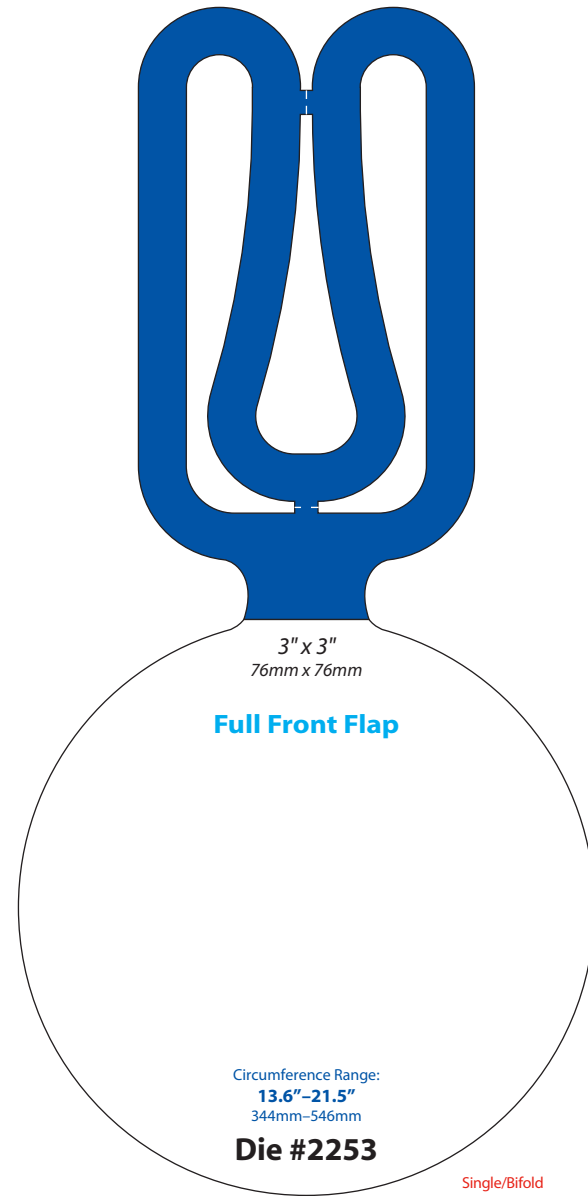

Allows background images to bleed

- NON-MATRIX
- SPOOLED
- P.O.D. SPOOLED
- TOTE
- MATRIX**
- MULTIPANEL
- NF SPOOLED
- TAB
- DUO

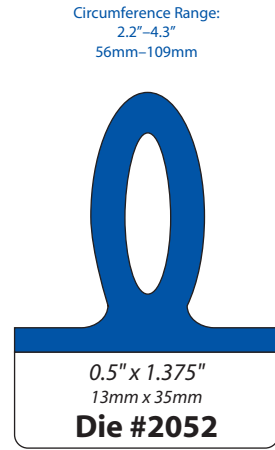

Single

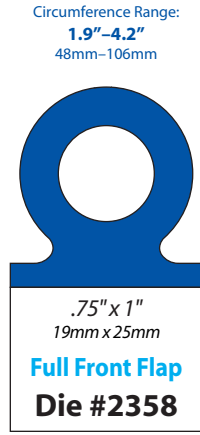

Single/Bifold

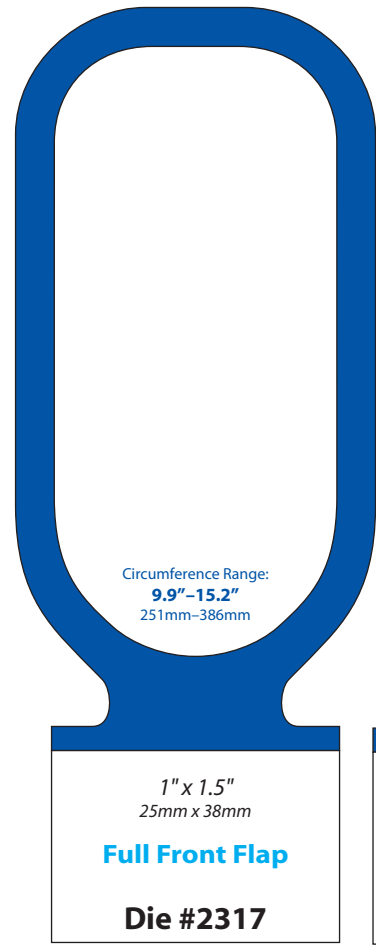

Single/Bifold

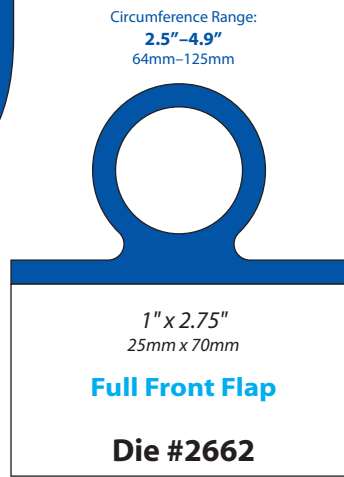

Single/Bifold



Single/Bifold

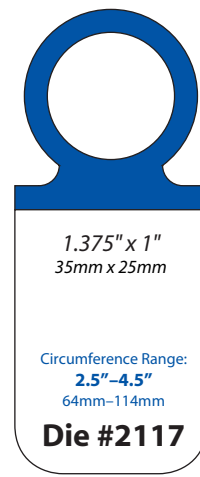

Single/Bifold  
Similar to standard die 2116

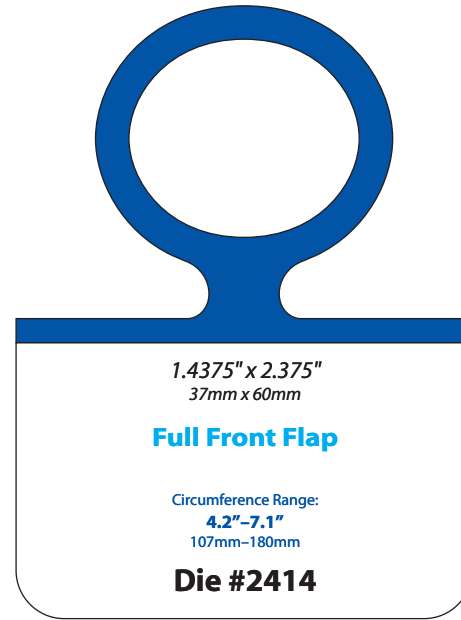

Single/Bifold

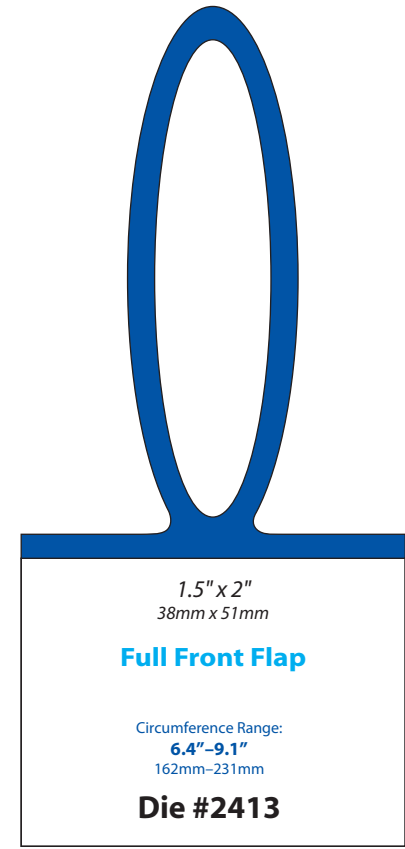

Single/Bifold

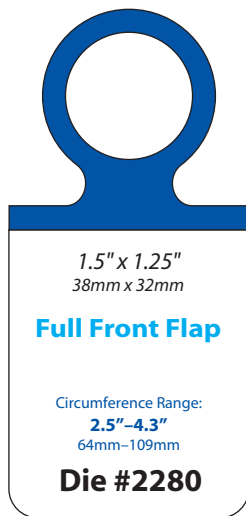

Single/Bifold

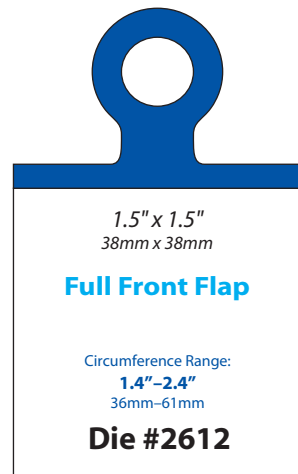

Single/Bifold

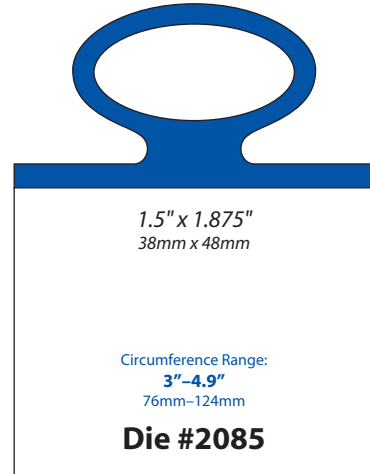

Single/Bifold

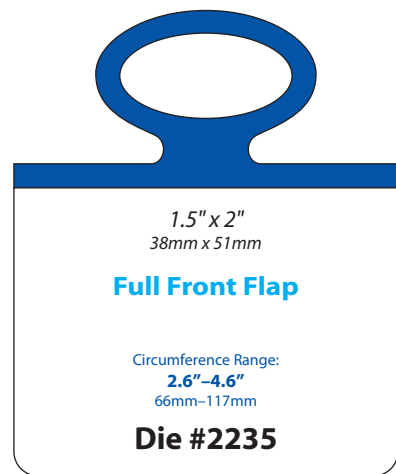

Single/Bifold

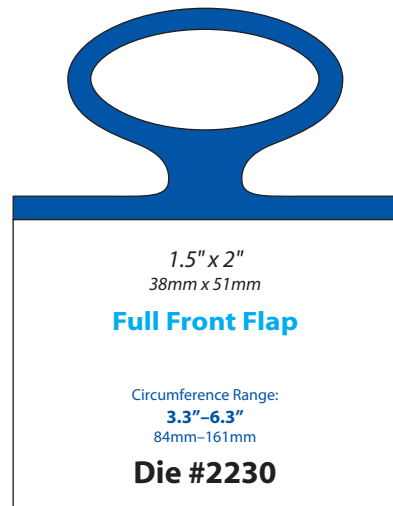

Single/Bifold

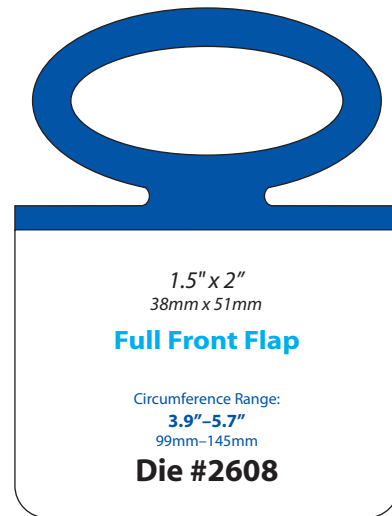

Single/Bifold

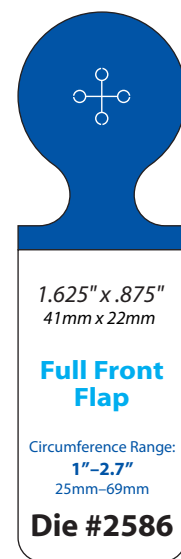

Single/Bifold

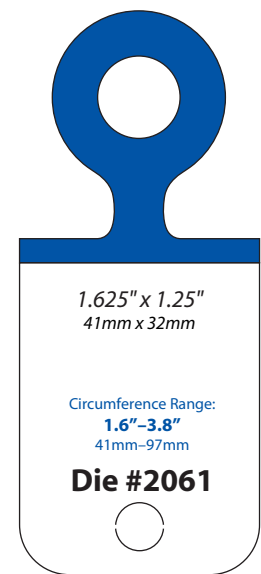

Single

- 2046
- 2052
- 2061
- 2085
- 2117
- 2176
- 2230
- 2235
- 2280
- 2317
- 2358
- 2413
- 2414
- 2586
- 2608
- 2612
- 2652
- 2662

Allows background images to bleed

NON-MATRIX

SPOOLED

P.O.D. SPOOLED

TOTE

MATRIX

MULTIPANEL

NF SPOOLED

TAB

DUO

- 2005
- 2036
- 2070
- 2072
- 2109
- 2138
- 2150
- 2201
- 2255
- 2281
- 2378
- 2425
- 2514
- 2623
- 2644
- 2681

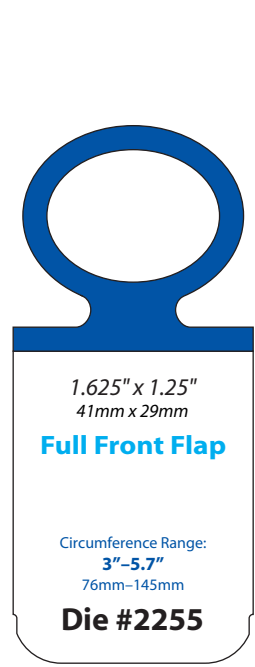

Single/Bifold

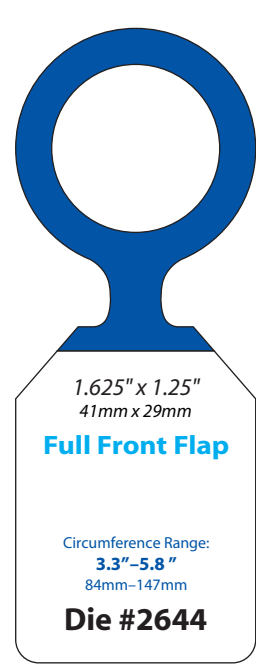

Single/Bifold

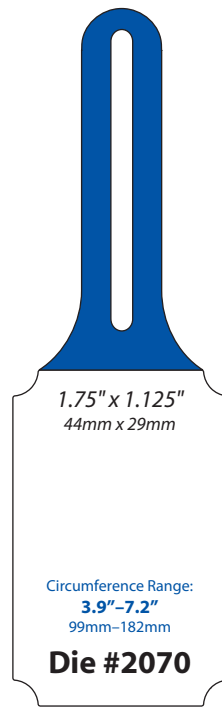

Single

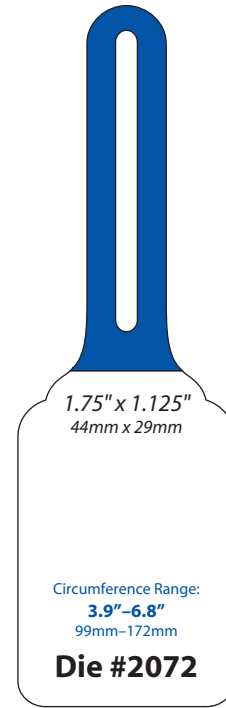

Single

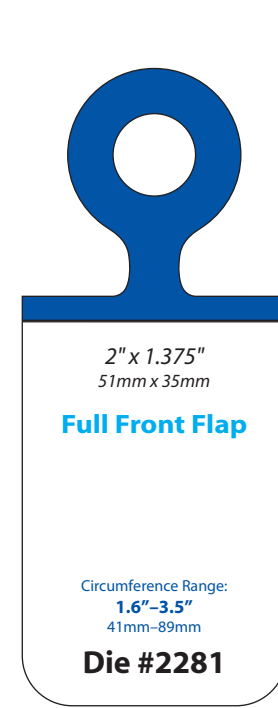

Single/Bifold

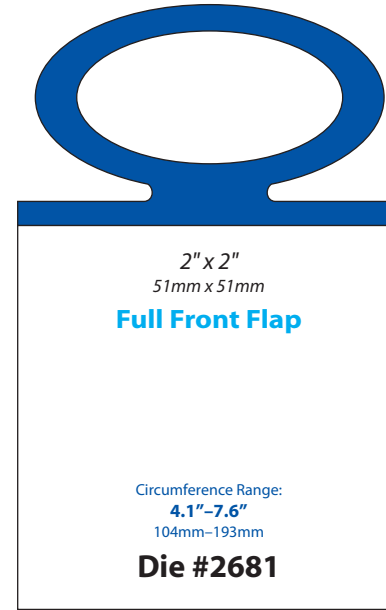

Single/Bifold

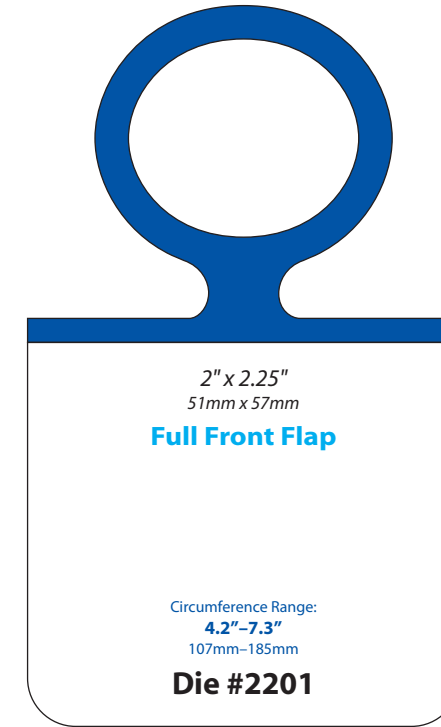

Single/Bifold

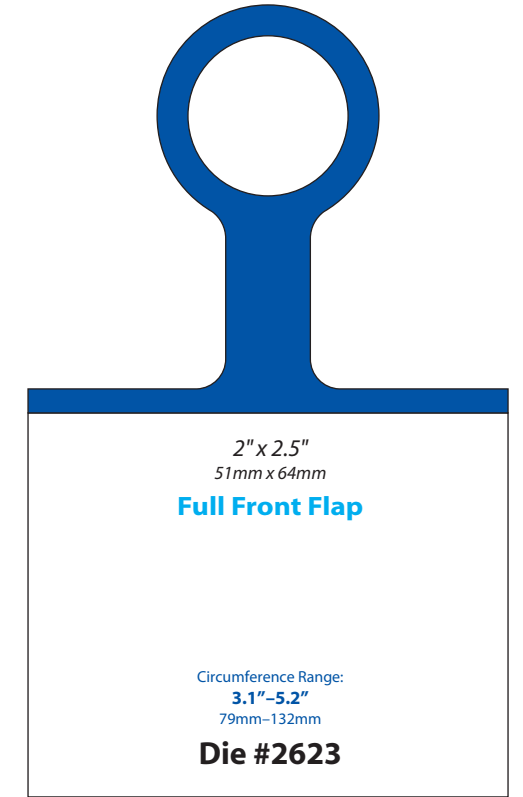

Single/Bifold

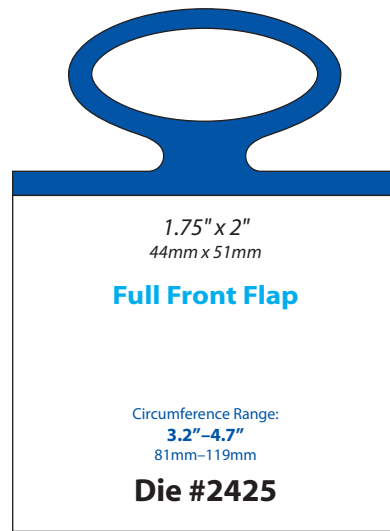

Single/Bifold



Single/Bifold

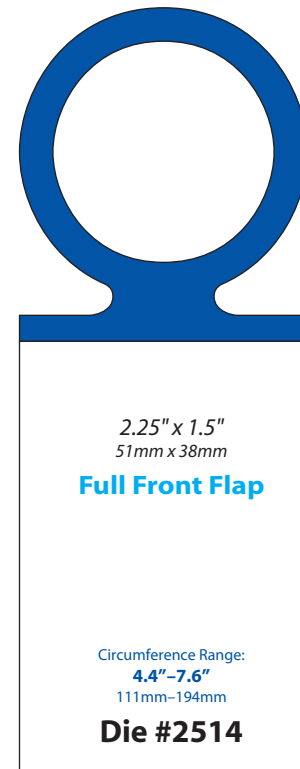

Single/Bifold

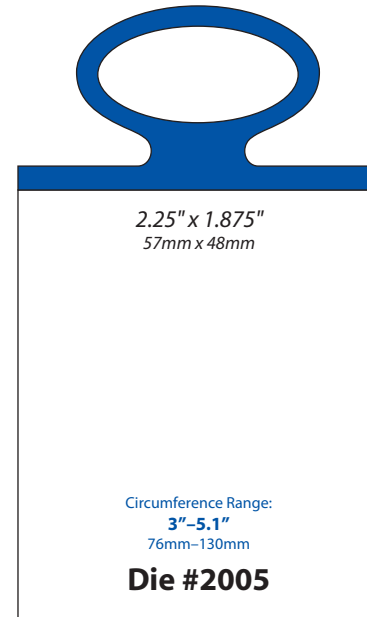

Single/Bifold

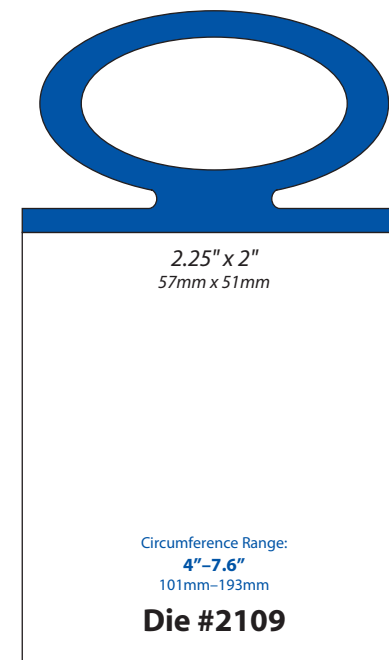

Single/Bifold  
Same as standard die 1946

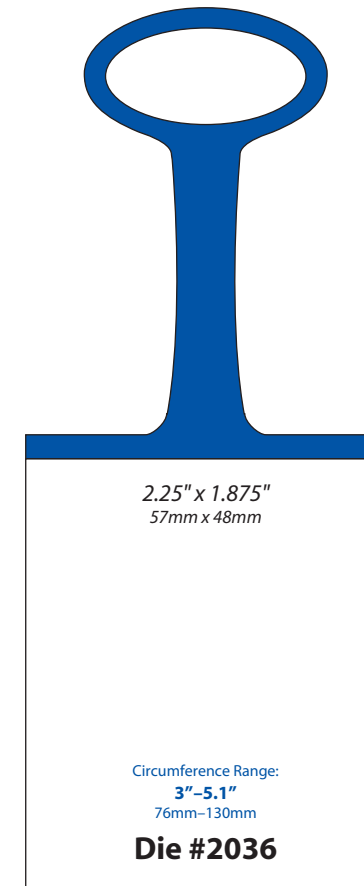

Single/Bifold

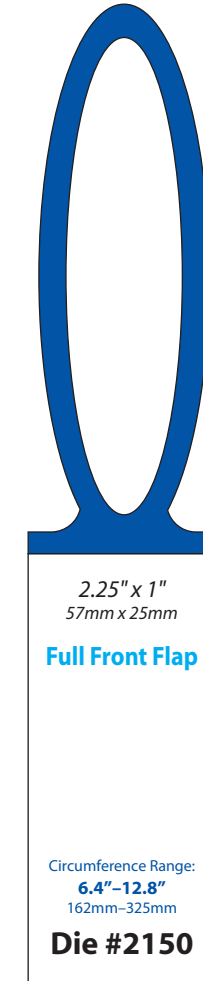

Single/Bifold  
Same as standard die 1823

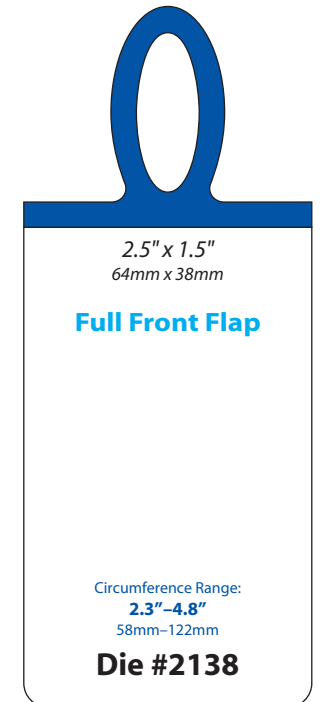

Single/Bifold

Allows background images to bleed

- NON-MATRIX
- SPOOLED
- P.O.D. SPOOLED
- TOTE
- MATRIX**
- MULTIPANEL
- NF SPOOLED
- TAB
- DUO

ElastiTag®  
BY BEDFORD

Updated: 05/26/22

Patent: elastitag.com/patents

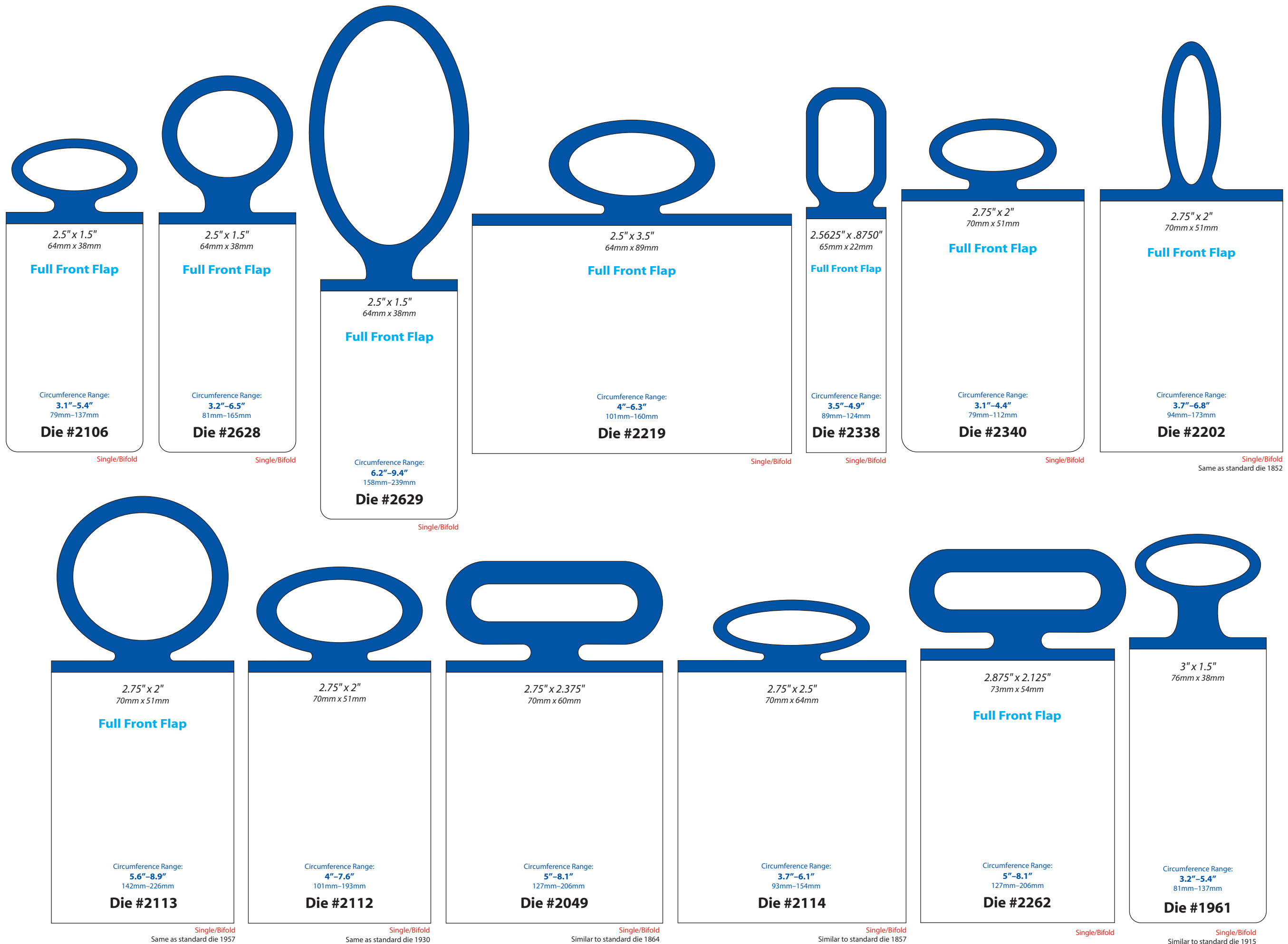

- 1961
- 2049
- 2106
- 2112
- 2113
- 2114
- 2202
- 2219
- 2262
- 2338
- 2340
- 2628
- 2629

Allows background images to bleed

- NON-MATRIX
- SPOOLED
- P.O.D. SPOOLED
- TOTE
- MATRIX**
- MULTIPANEL
- NF SPOOLED
- TAB
- DUO

- 1991
- 2069
- 2071
- 2110
- 2298
- 2362
- 2426
- 2594

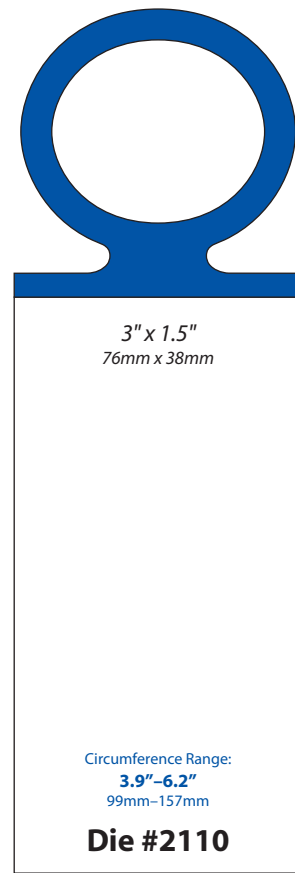

Single/Bifold  
Same as standard die 1942 and spooled die 2030

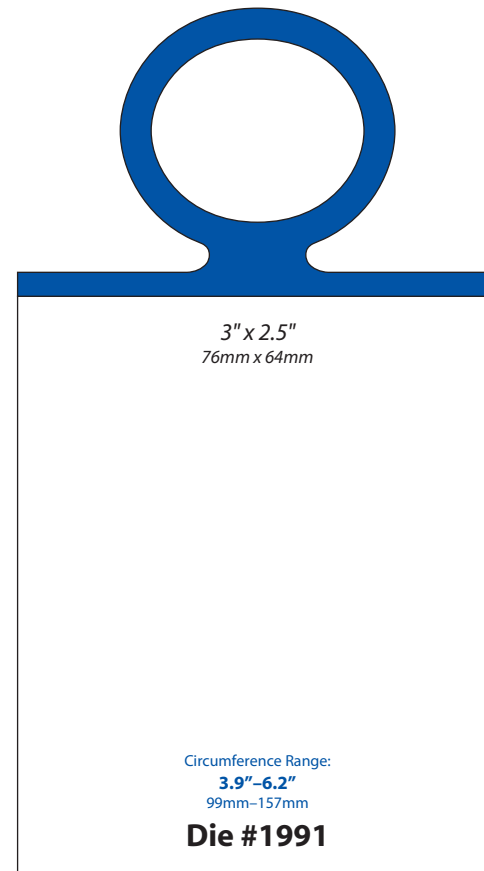

Single/Bifold

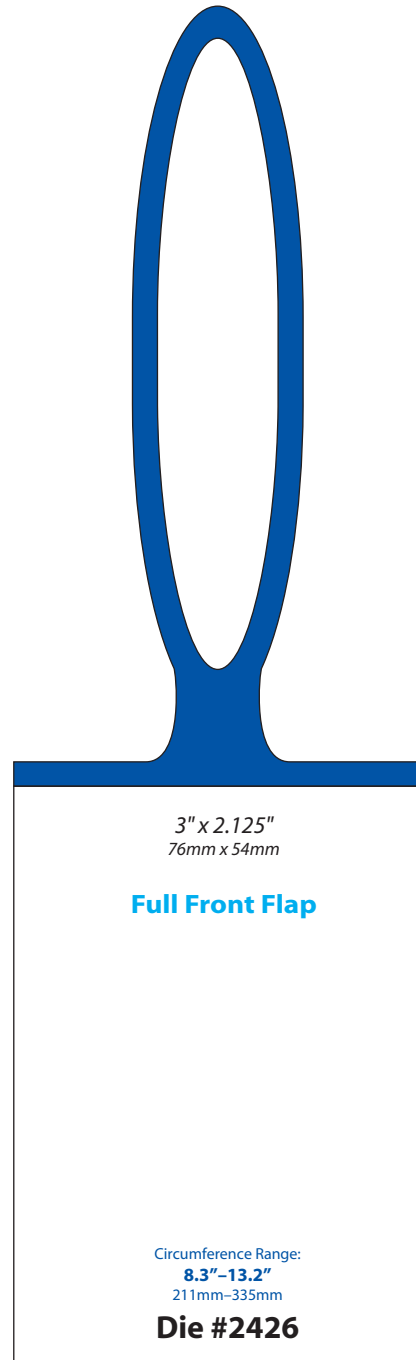

Single/Bifold

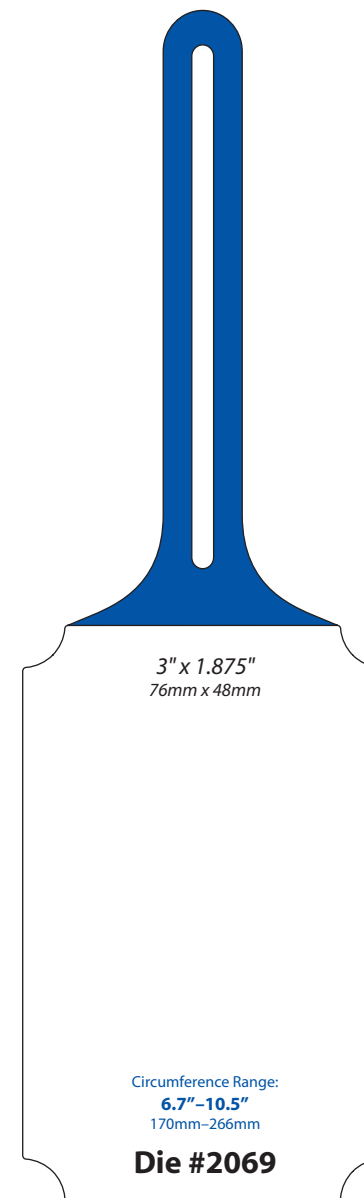

Single

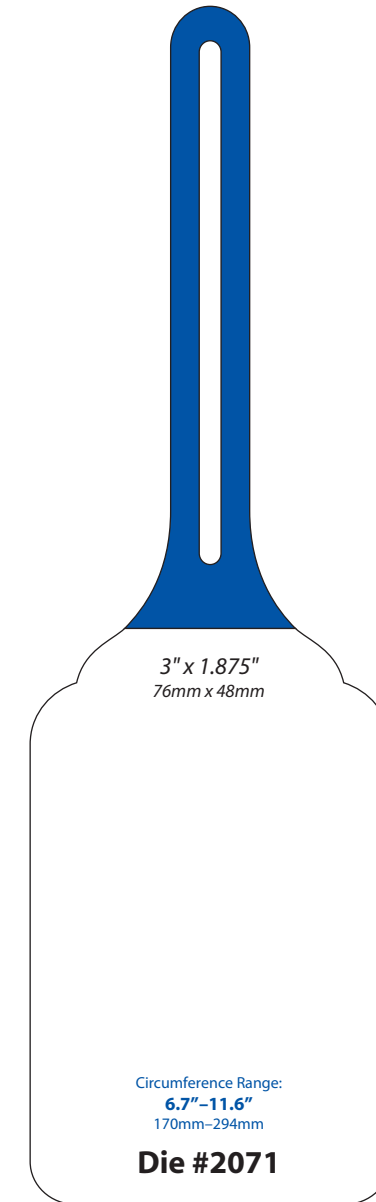

Single

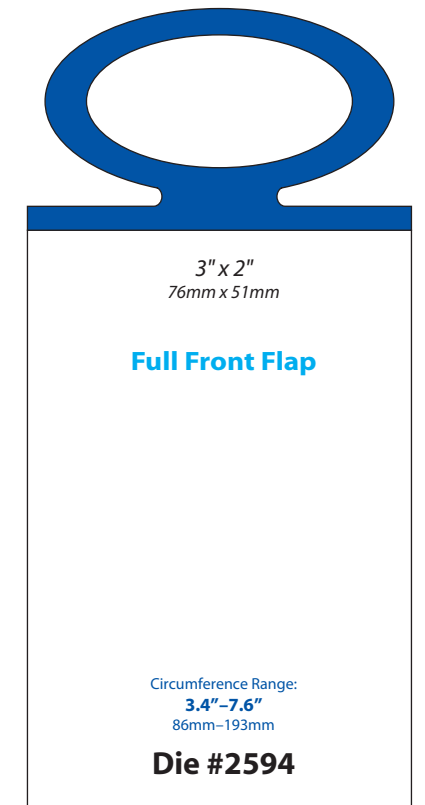

Single/Bifold

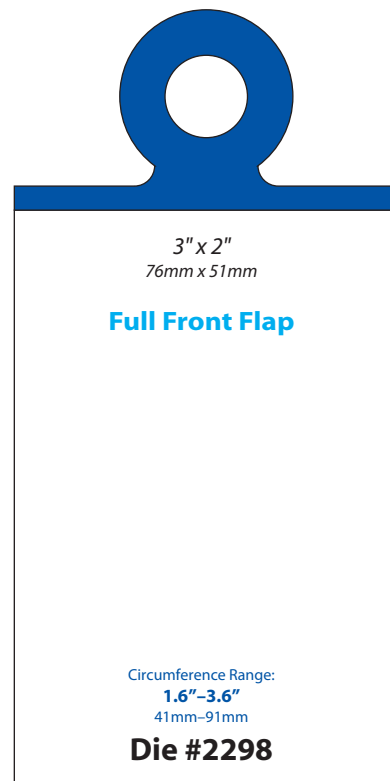

Single/Bifold

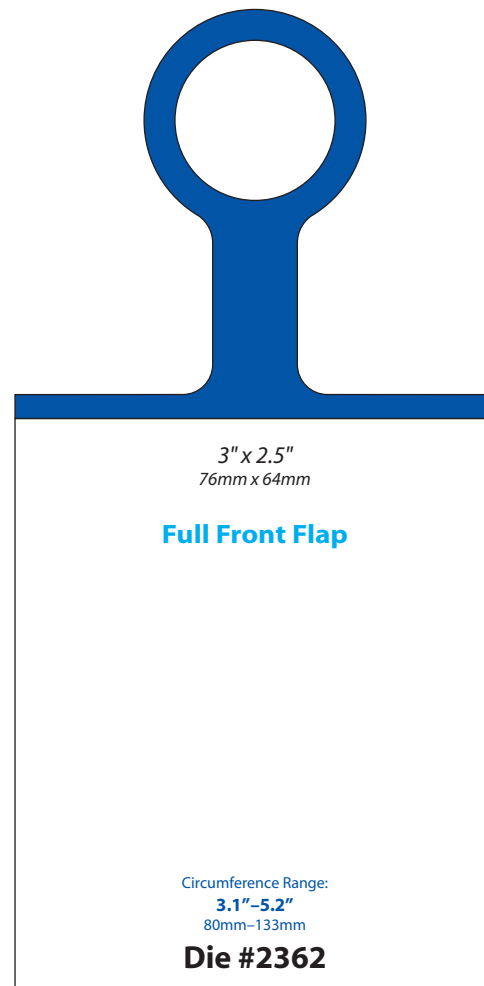

Single/Bifold

Allows background images to bleed

- NON-MATRIX
- SPOOLED
- P.O.D. SPOOLED
- TOTE
- MATRIX**
- MULTIPANEL
- NF SPOOLED
- TAB
- DUO

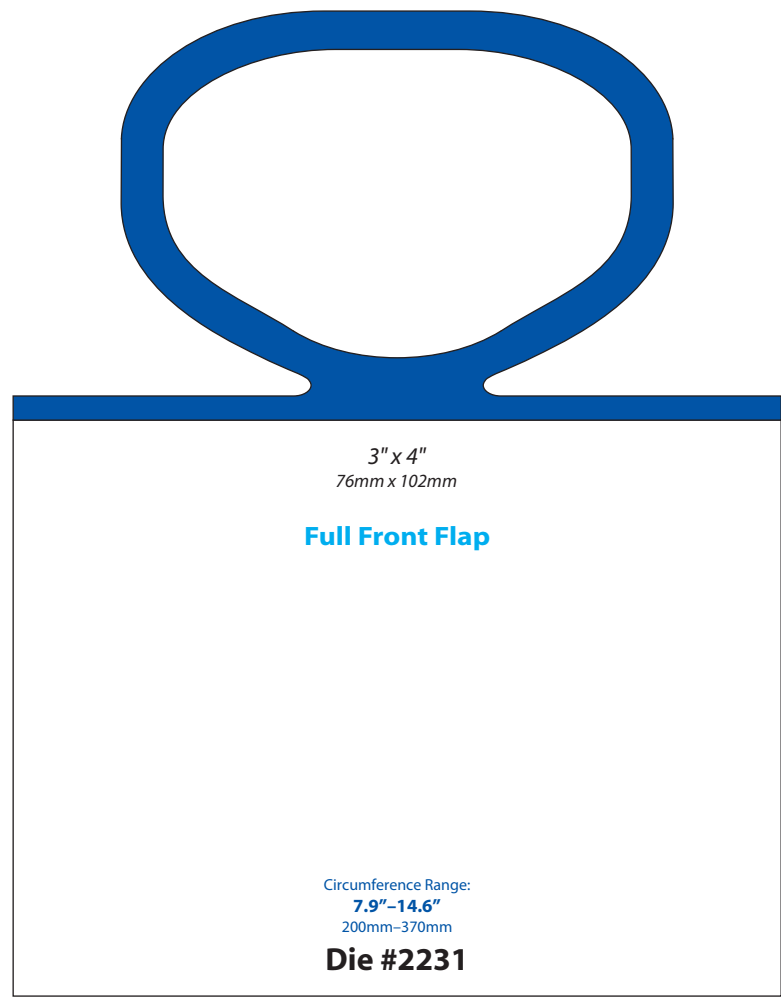

Single/Bifold  
Same as standard die 2078

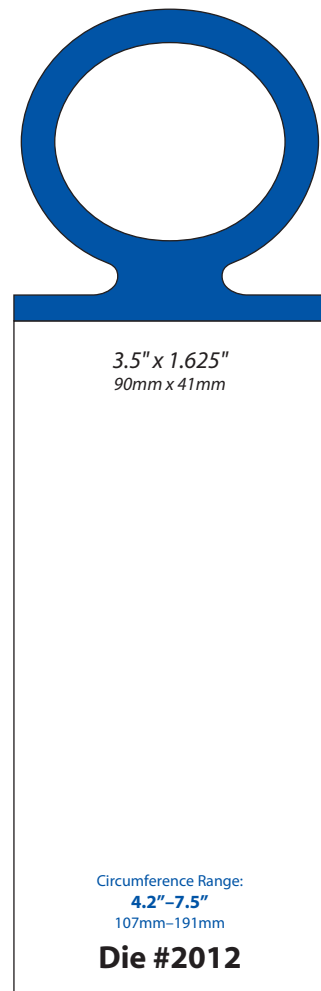

Single/Bifold

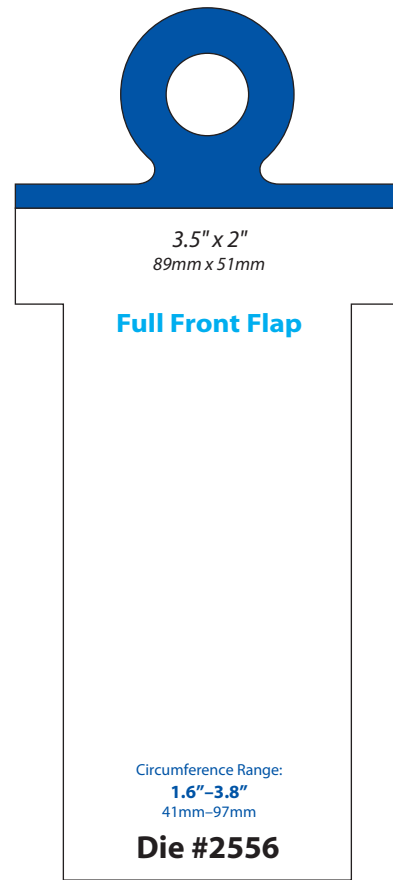

Single/Bifold

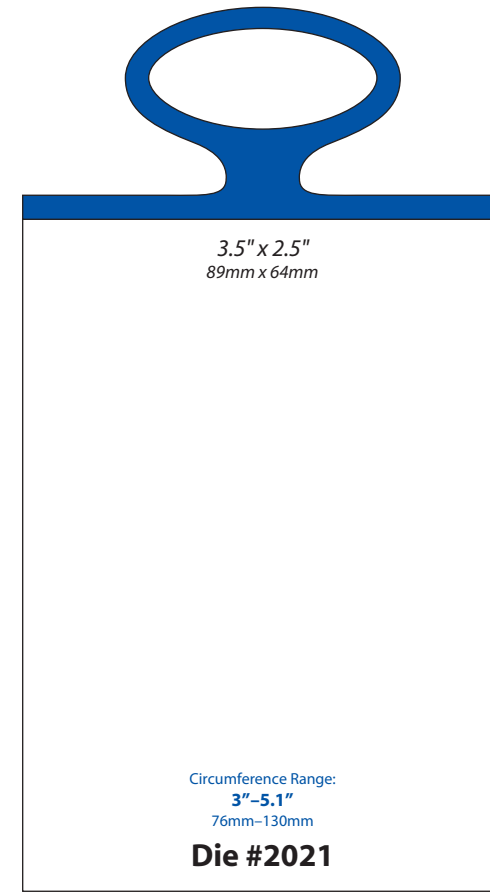

Single/Bifold

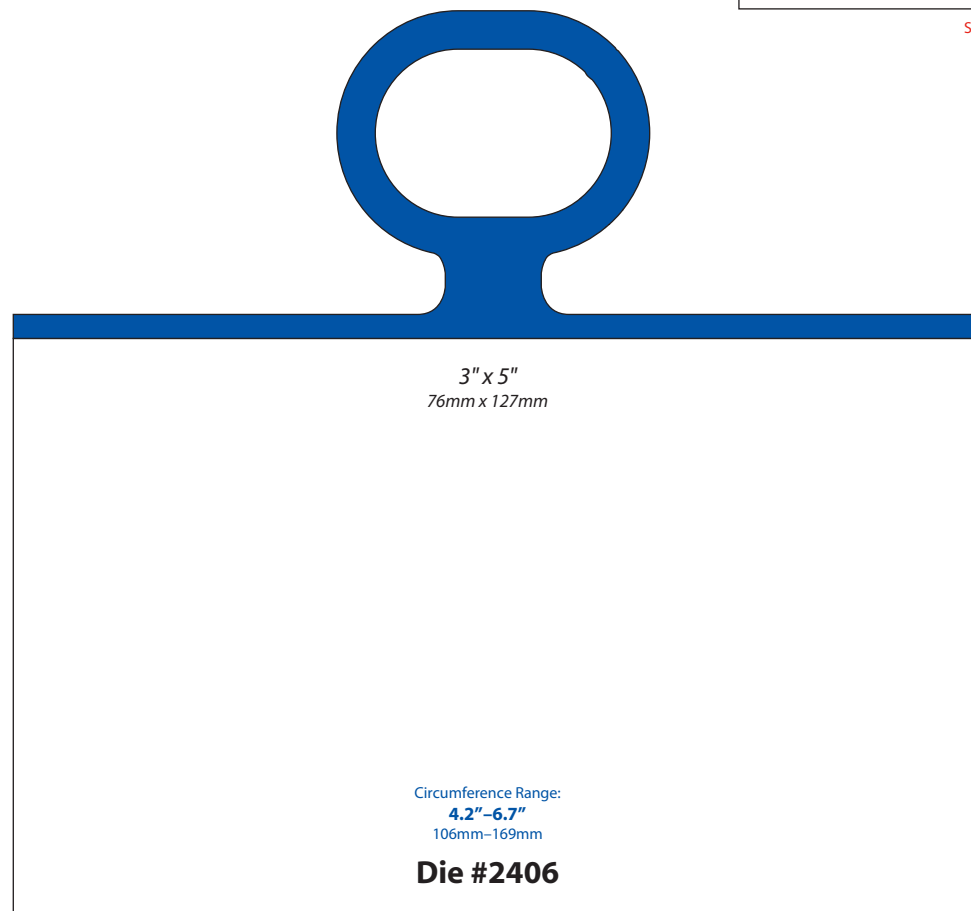

Single

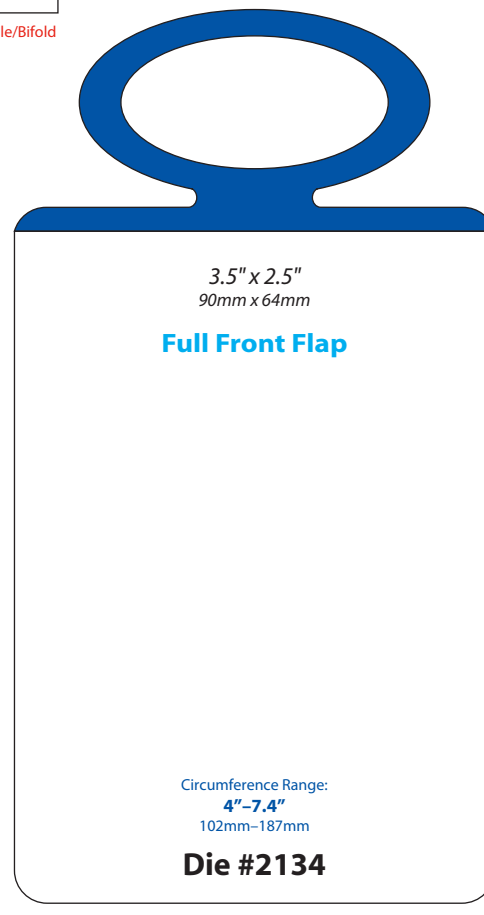

Single/Bifold

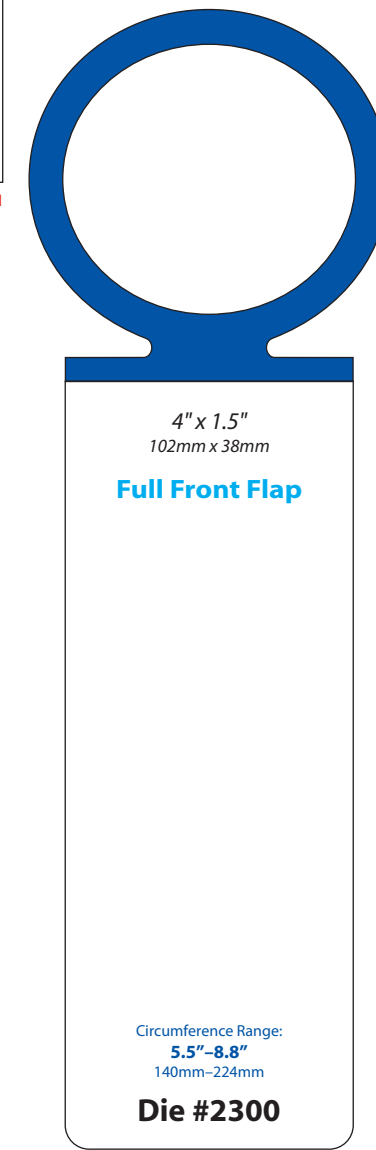

Single/Bifold

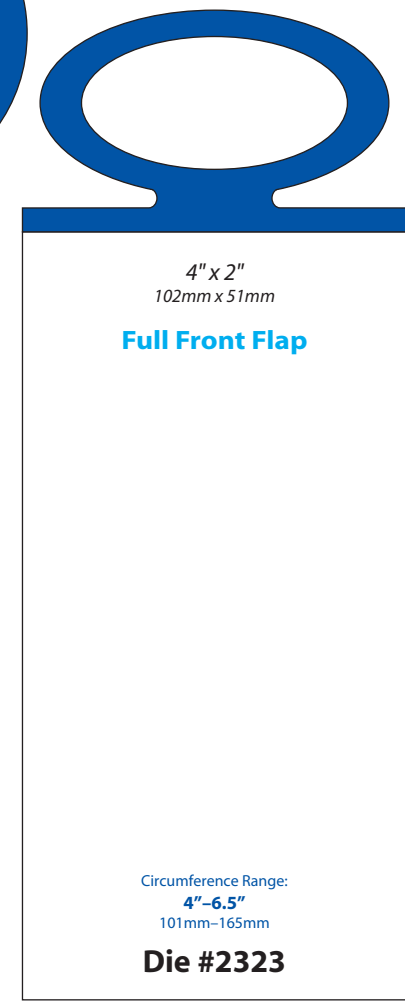

Single/Bifold  
Same as standard dies 2008 & 2028

- 2012
- 2021
- 2134
- 2231
- 2300
- 2323
- 2406
- 2556

Allows background images to bleed

- NON-MATRIX
- SPOOLED
- P.O.D. SPOOLED
- TOTE
- MATRIX**
- MULTIPANEL
- NF SPOOLED
- TAB
- DUO

- 2147
- 2238
- 2248
- 2359
- 2654

Allows background images to bleed

- NON-MATRIX
- SPOOLED
- P.O.D. SPOOLED
- TOTE
- MATRIX**
- MULTIPANEL
- NF SPOOLED
- TAB
- DUO

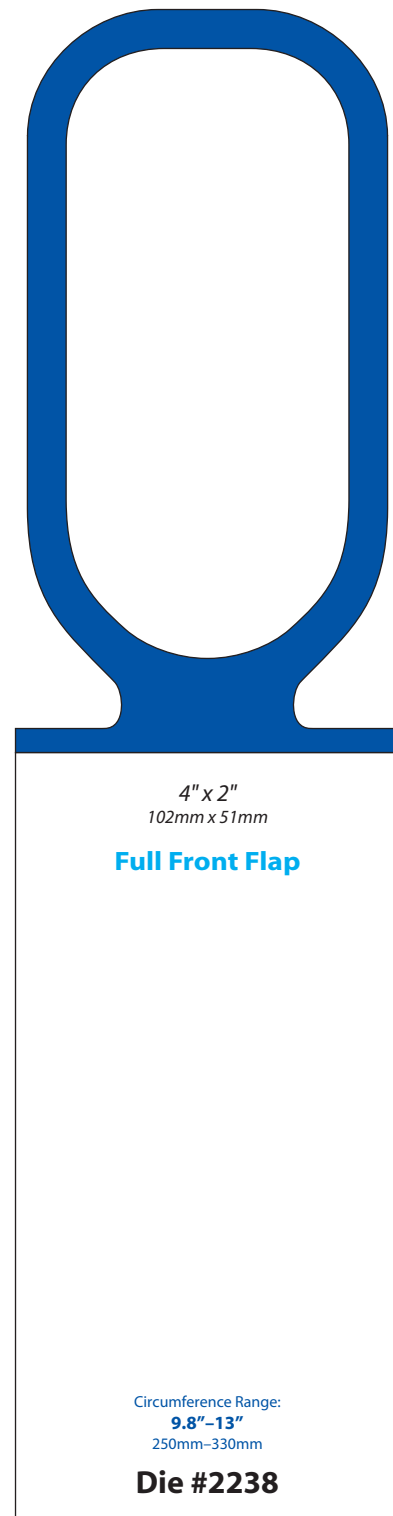

Single/Bifold



Single/Bifold

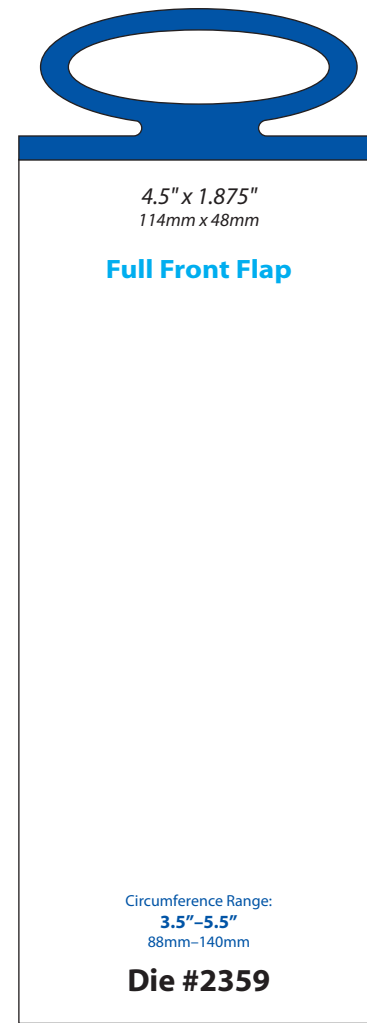

Single/Bifold



Single/Bifold

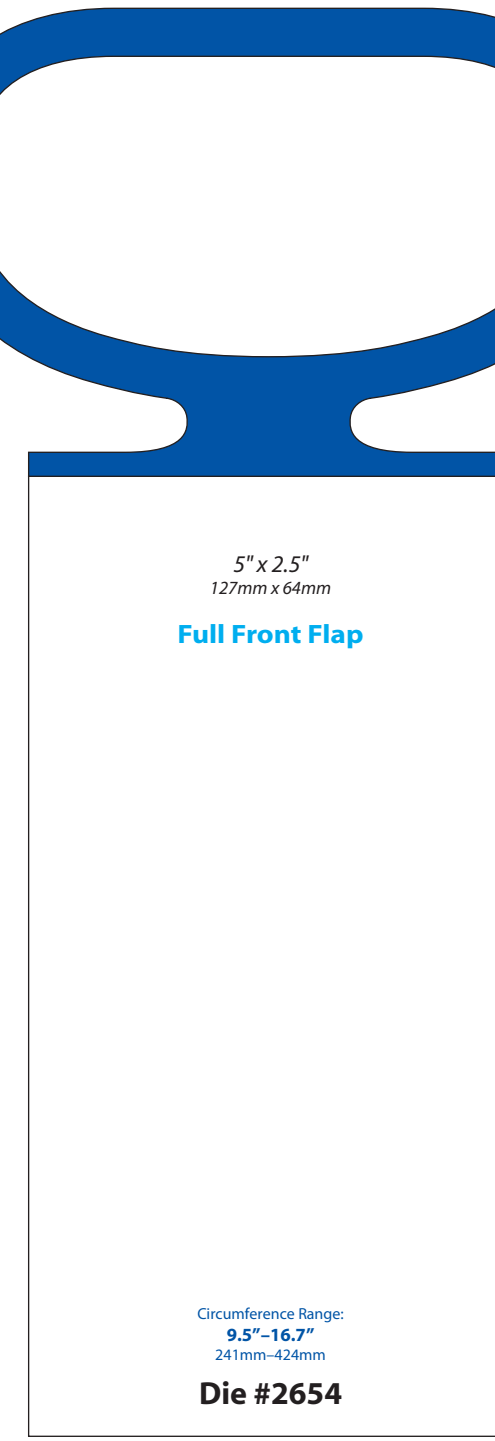

Single/Bifold



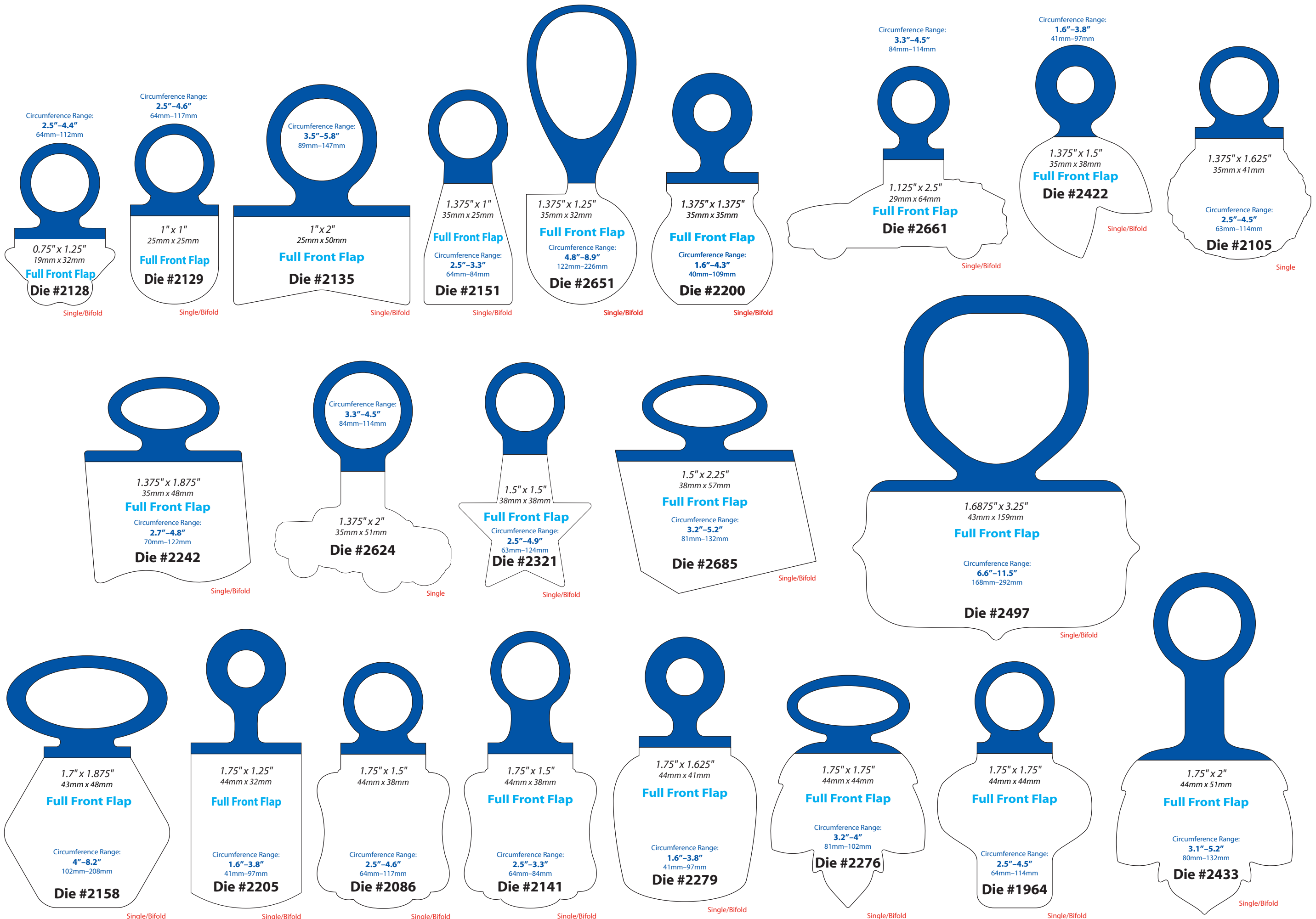

- 1964
- 2086
- 2105
- 2128
- 2129
- 2135
- 2141
- 2151
- 2158
- 2200
- 2205
- 2242
- 2276
- 2279
- 2321
- 2422
- 2433
- 2497
- 2624
- 2651
- 2661
- 2685

Allows background images to bleed

NON-MATRIX

SPOOLED

P.O.D. SPOOLED

TOTE

MATRIX

MULTIPANEL

NF SPOOLED

TAB

DUO

ElastiTag<sup>®</sup>  
BY BEDFORD

Updated: 05/26/22

Patent: elasti-tag.com/patents

- 2038
- 2051
- 2097
- 2103
- 2130
- 2160
- 2322
- 2376
- 2419
- 2420
- 2527
- 2591
- 2600



Single/Bifold



Single/Bifold



Single/Bifold

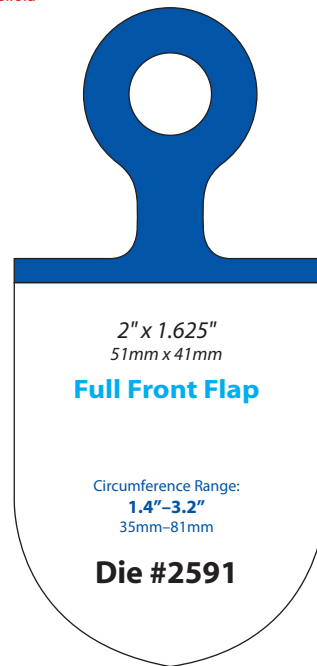

Single/Bifold



Single/Bifold

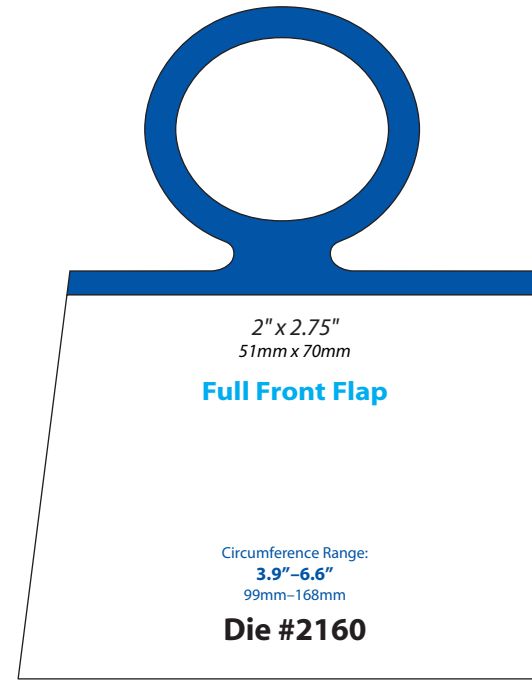

Single/Bifold

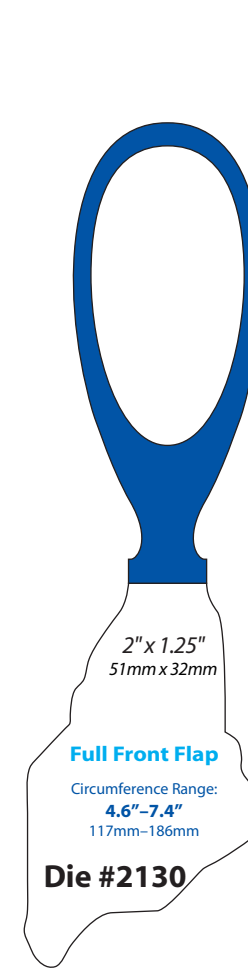

Single/Bifold

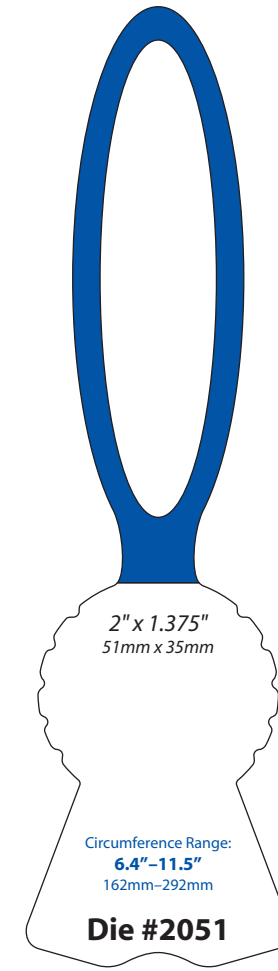

Single

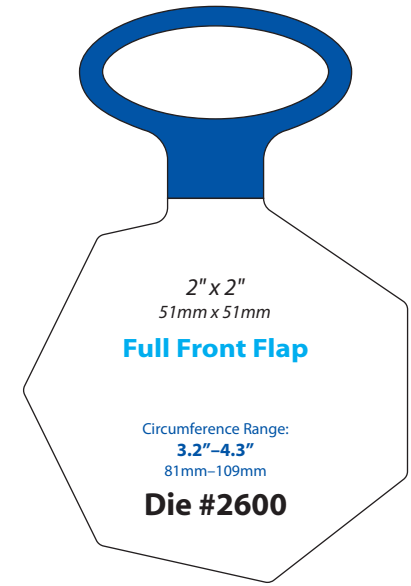

Single/Bifold

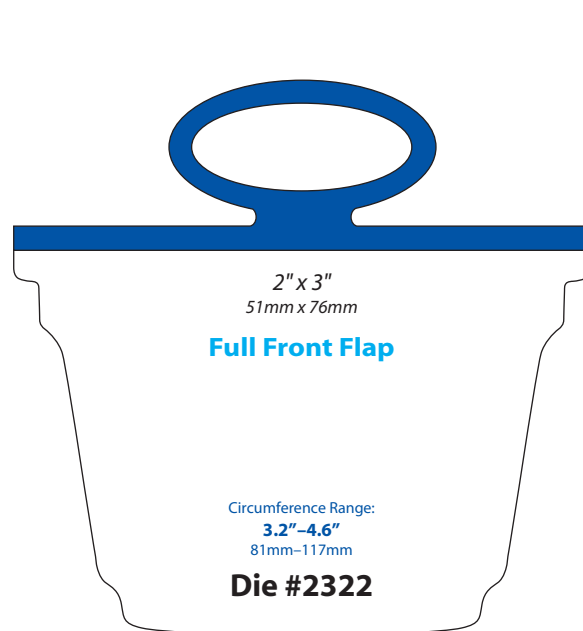

Single/Bifold

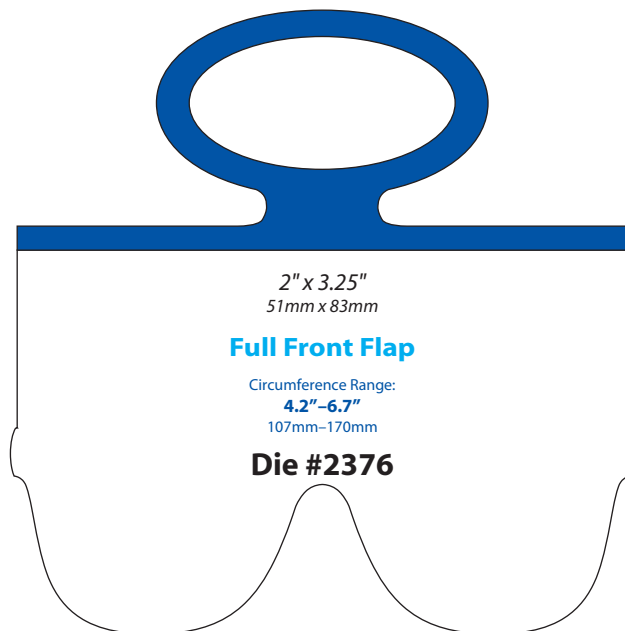

Single/Bifold

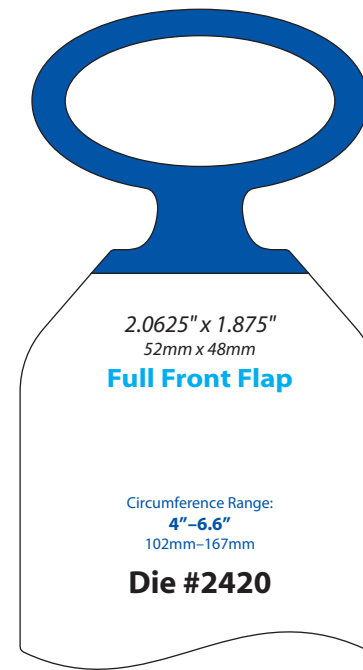

Single/Bifold

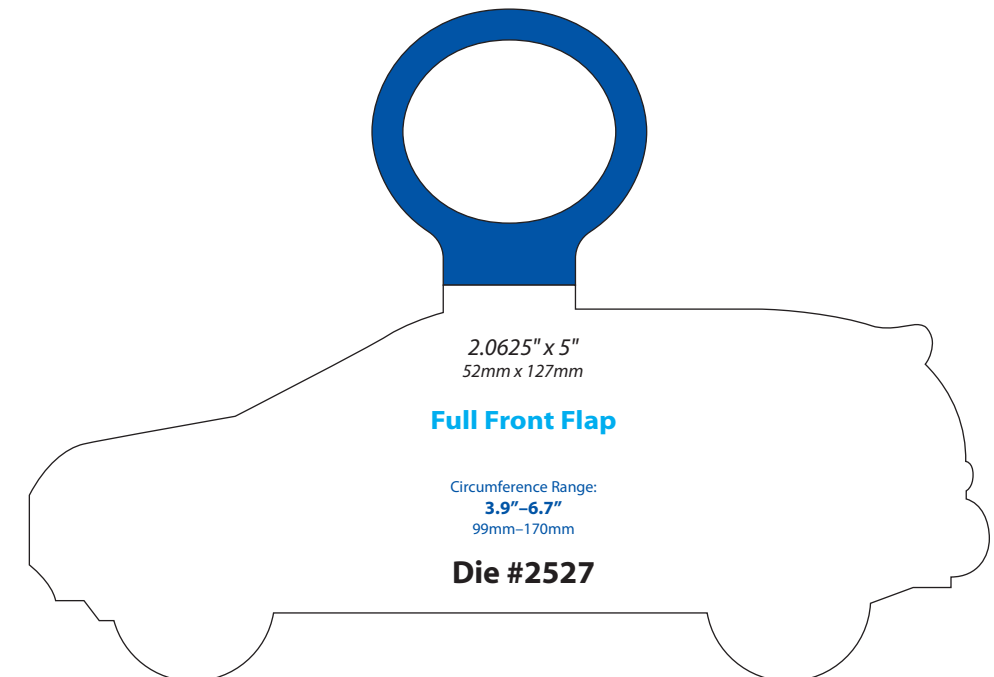

Single/Bifold

Allows background images to bleed

- NON-MATRIX
- SPOOLED
- P.O.D. SPOOLED
- TOTE
- MATRIX**
- MULTIPANEL
- NF SPOOLED
- TAB
- DUO

ElastiTag<sup>®</sup>  
BY BEDFORD

Updated: 05/26/22

Patent: elastitag.com/patents

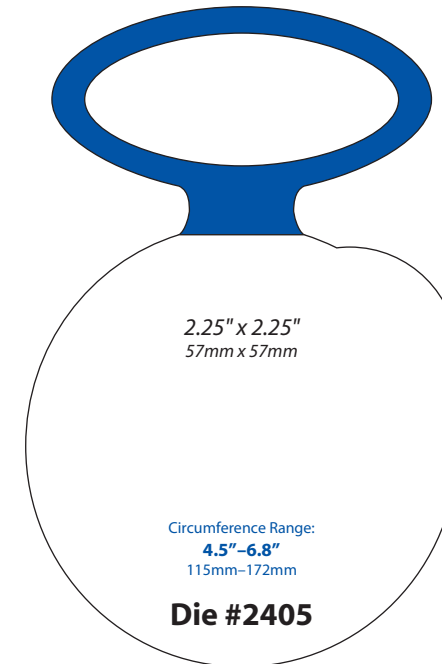
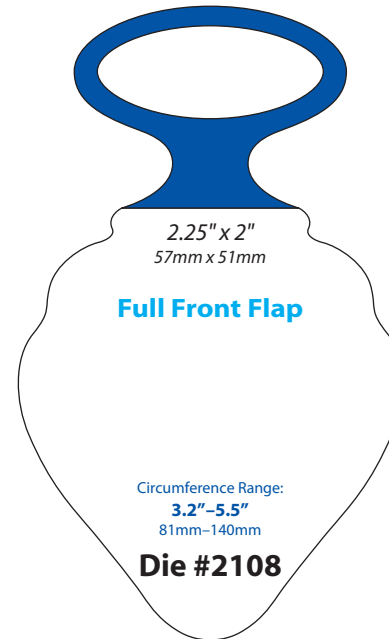
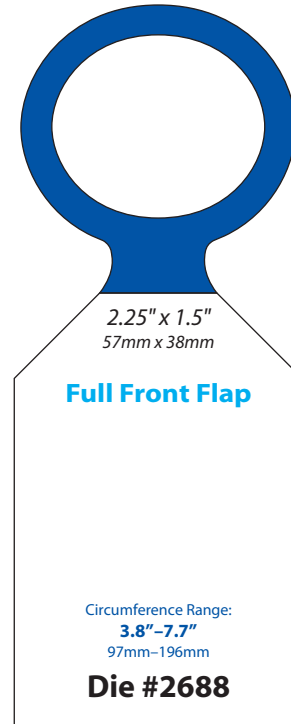
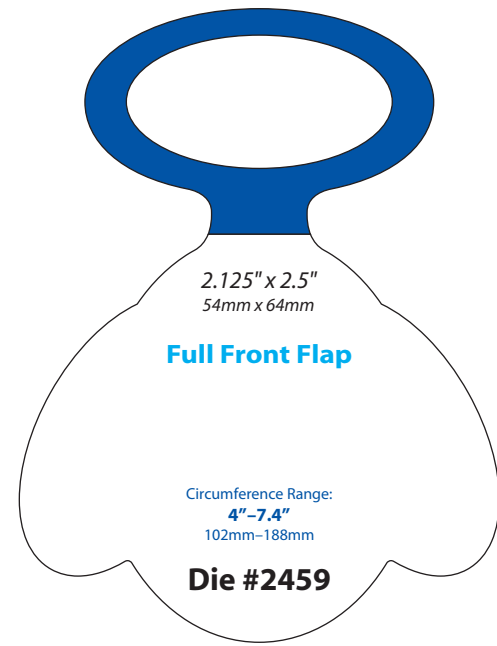
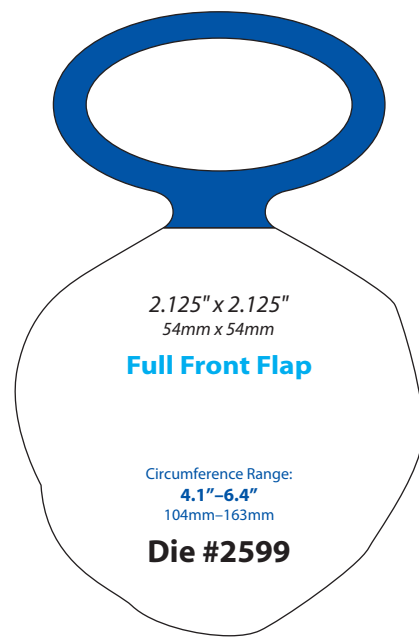

Single/Bifold

Single/Bifold

Single/Bifold

Single/Bifold

Single

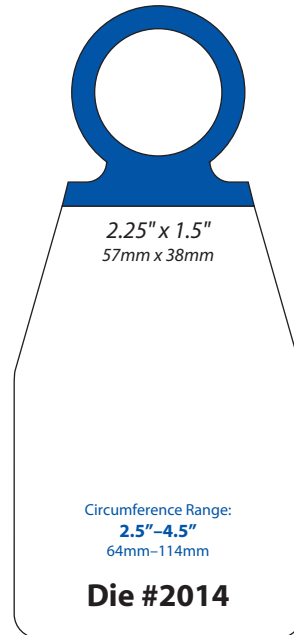
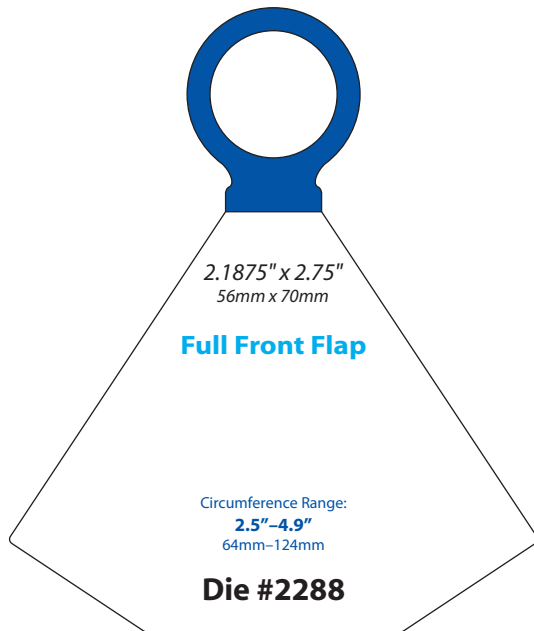

Single/Bifold

Single/Bifold

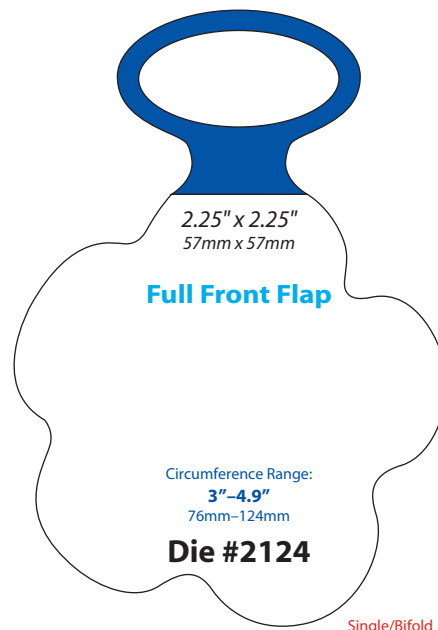

Single/Bifold

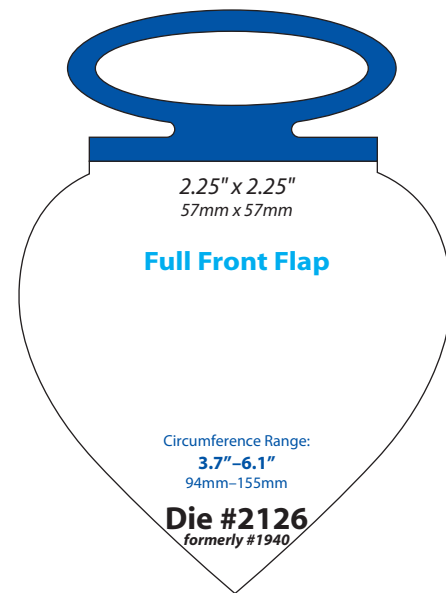

Single/Bifold

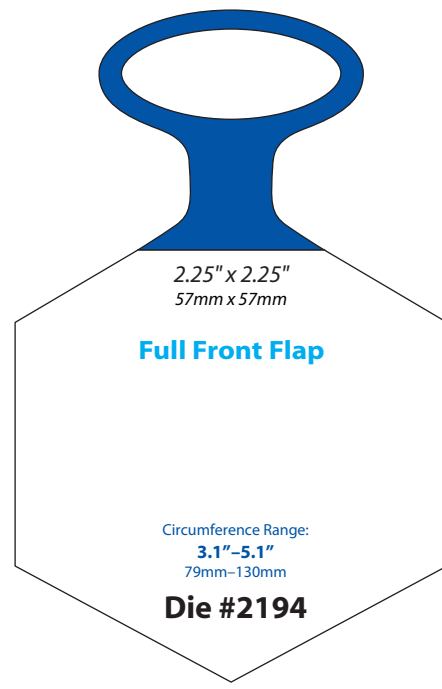

Single/Bifold



Single/Bifold

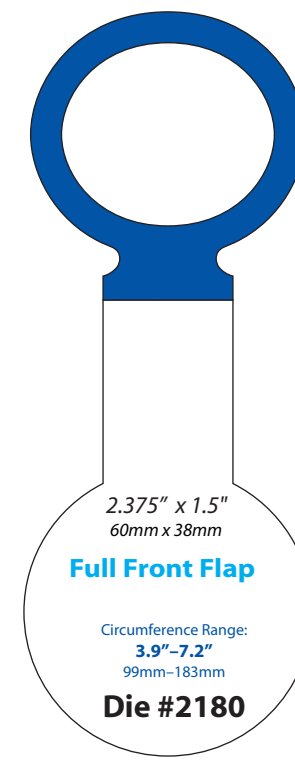

Single/Bifold

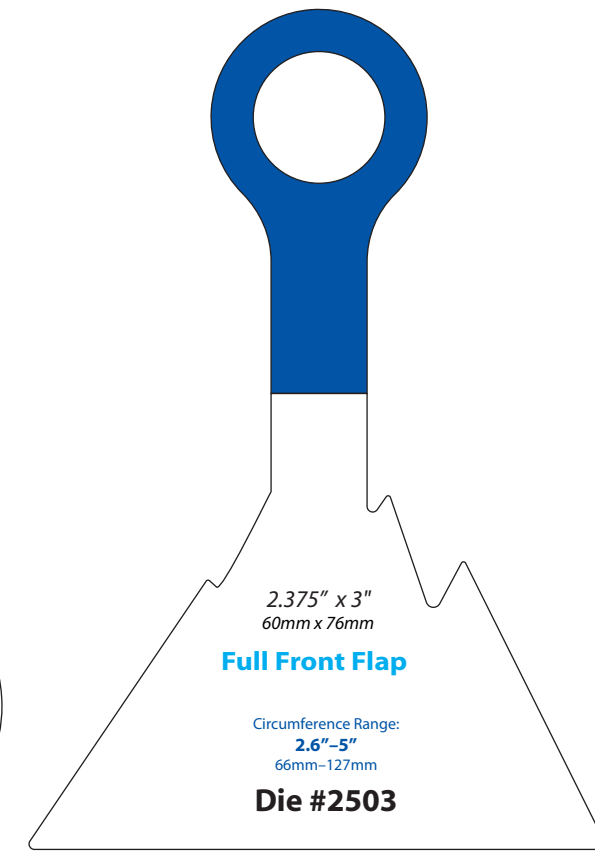

Single/Bifold

- 1974
- 2014
- 2108
- 2124
- 2126
- 2180
- 2194
- 2288
- 2405
- 2459
- 2503
- 2599
- 2688

Allows background images to bleed

- NON-MATRIX
- SPOOLED
- P.O.D. SPOOLED
- TOTE
- MATRIX**
- MULTIPANEL
- NF SPOOLED
- TAB
- DUO

- 2053
- 2063
- 2207
- 2258
- 2283
- 2335
- 2337
- 2399
- 2445
- 2465

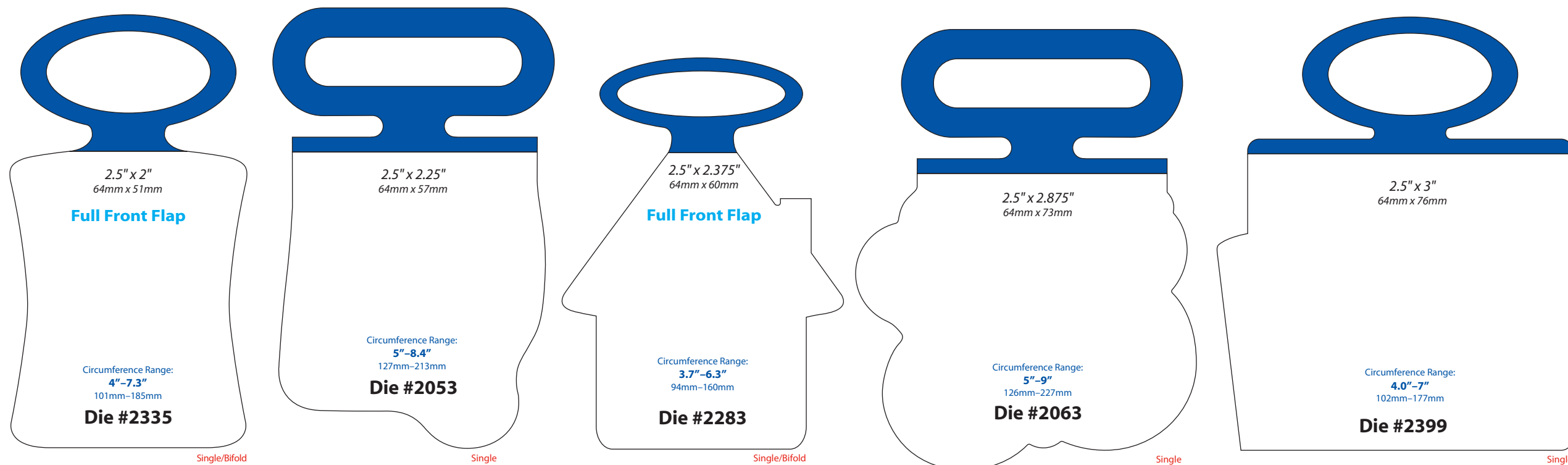
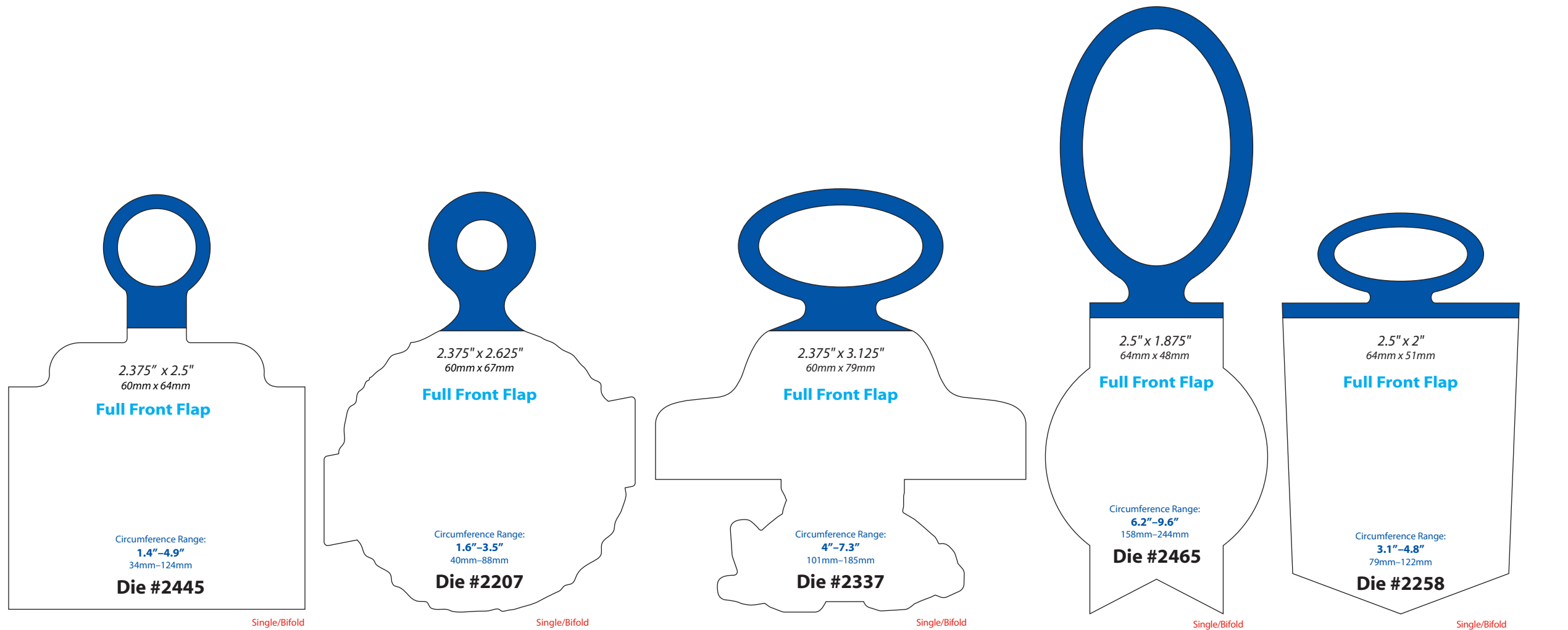

Allows background images to bleed

NON-MATRIX

SPOOLED

P.O.D. SPOOLED

TOTE

**MATRIX**

MULTIPANEL

NF SPOOLED

TAB

DUO

- 2120
- 2316
- 2423
- 2598
- 2668
- 2680

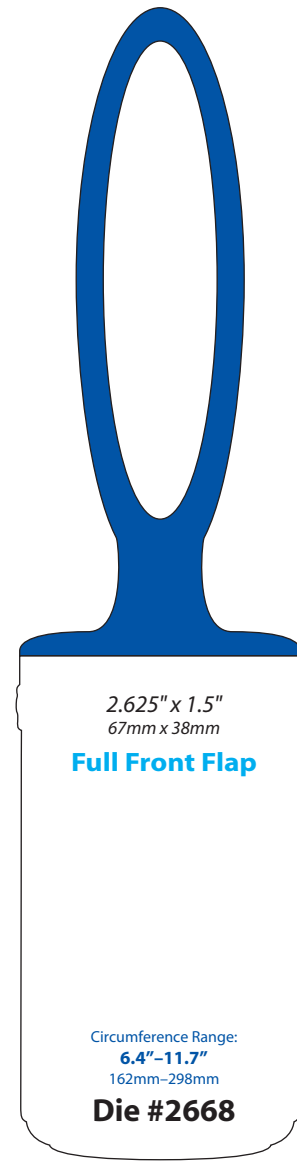

Single/Bifold

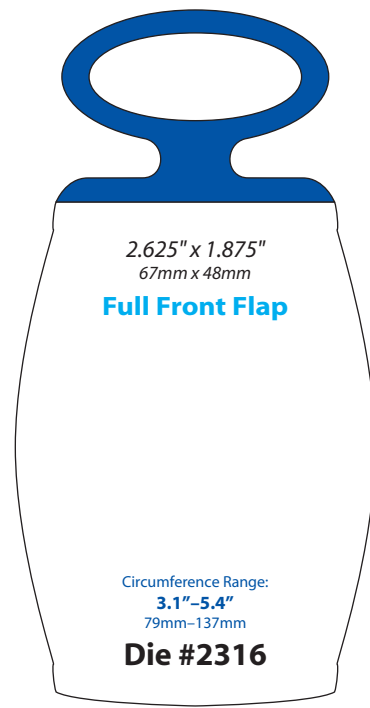

Single/Bifold

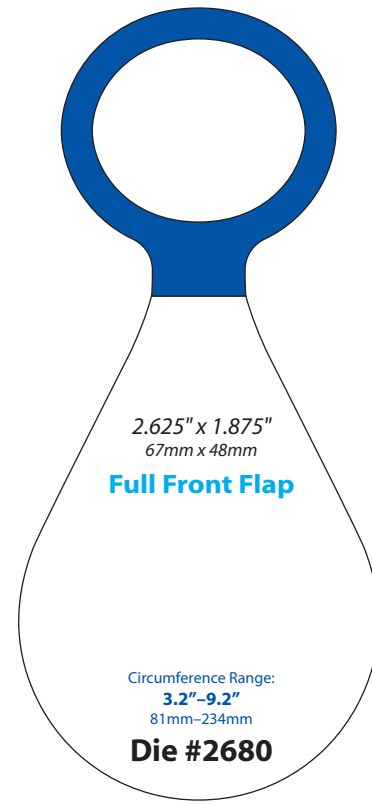

Single/Bifold

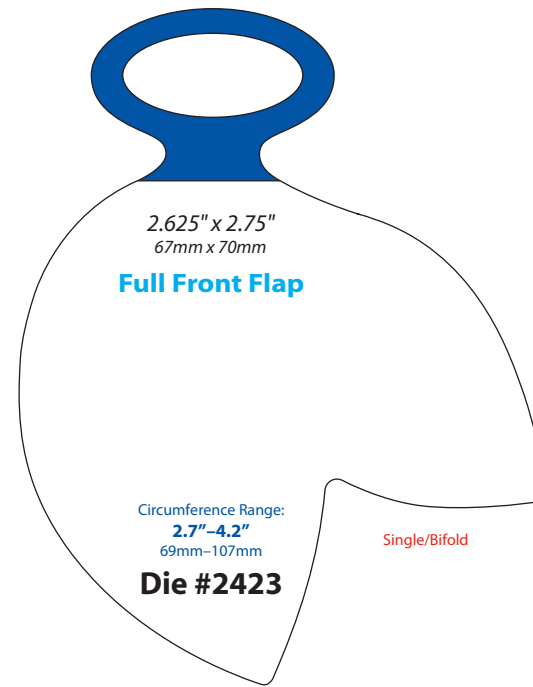

Single/Bifold



Single/Bifold

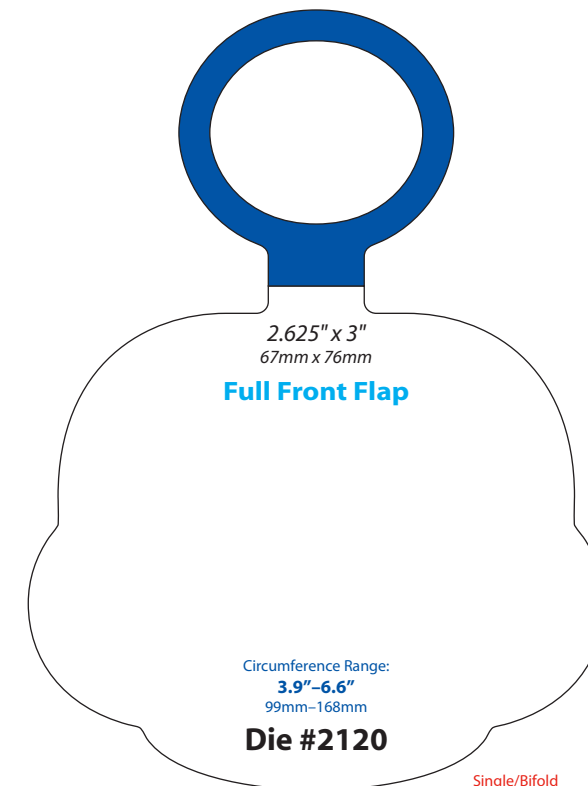

Single/Bifold

Allows background images to bleed

- NON-MATRIX
- SPOOLED
- P.O.D. SPOOLED
- TOTE
- MATRIX**
- MULTIPANEL
- NF SPOOLED
- TAB
- DUO

- 2073
- 2115
- 2303
- 2357
- 2373
- 2526

Allows background images to bleed

NON-MATRIX

SPOOLED

P.O.D. SPOOLED

TOTE

MATRIX

MULTIPANEL

NF SPOOLED

TAB

DUO

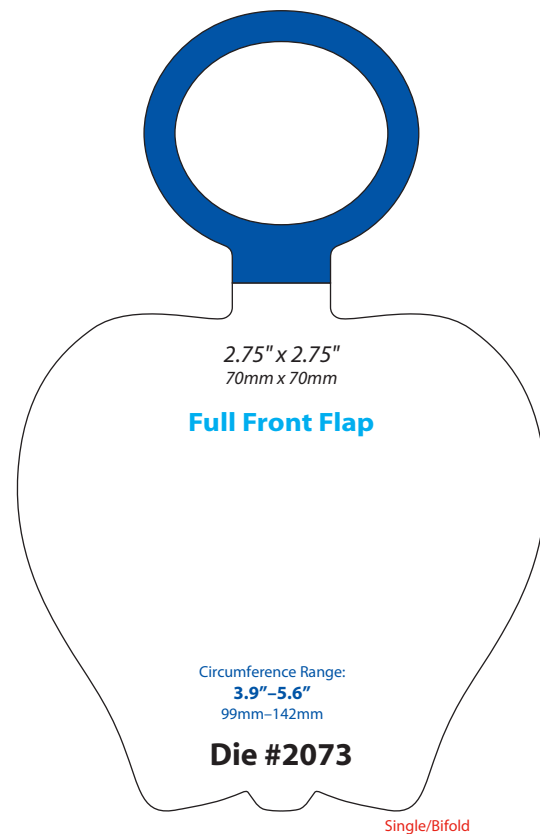

Single/Bifold

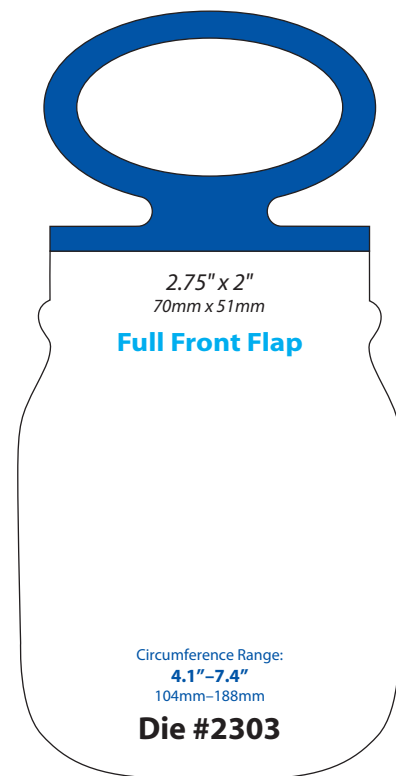

Single/Bifold

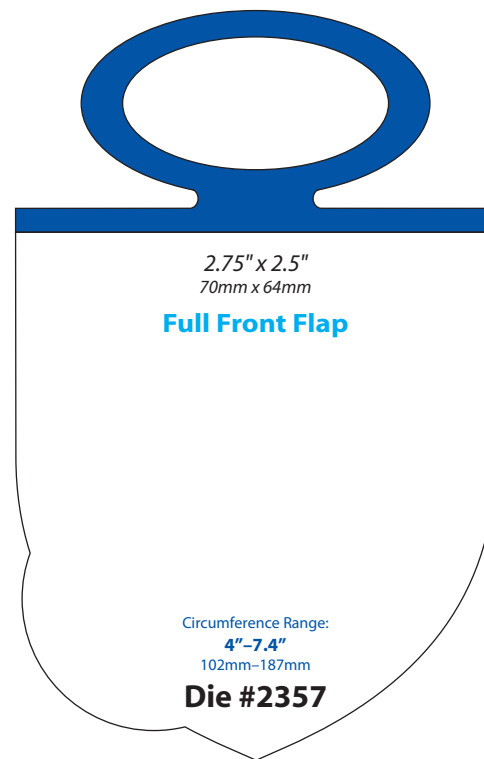

Single/Bifold

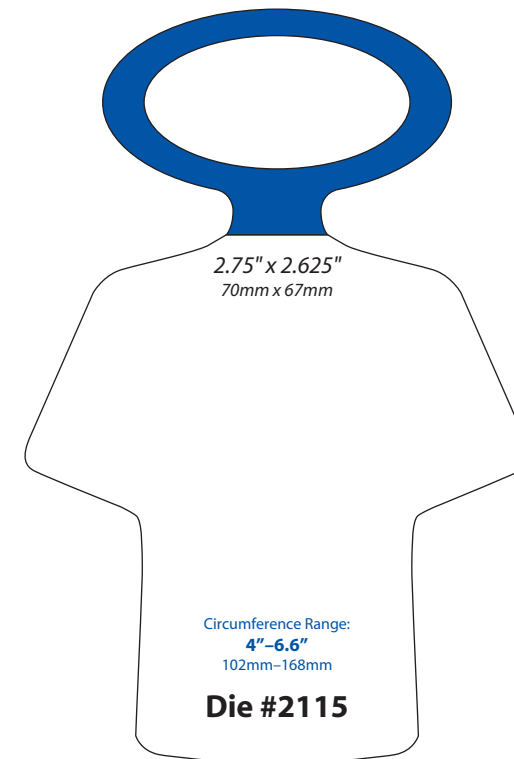

Single/Bifold

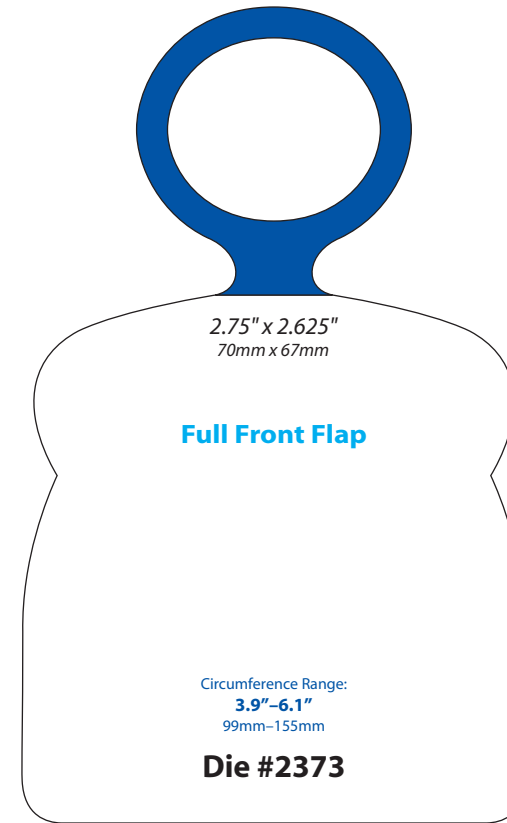

Single/Bifold

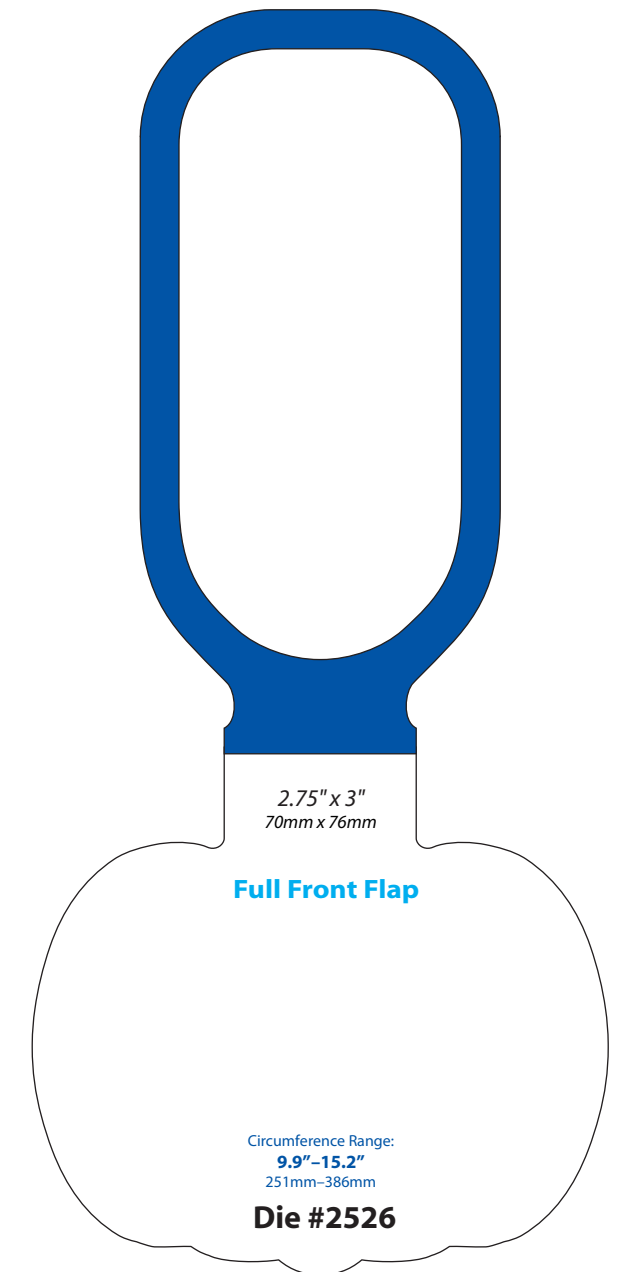

Single/Bifold

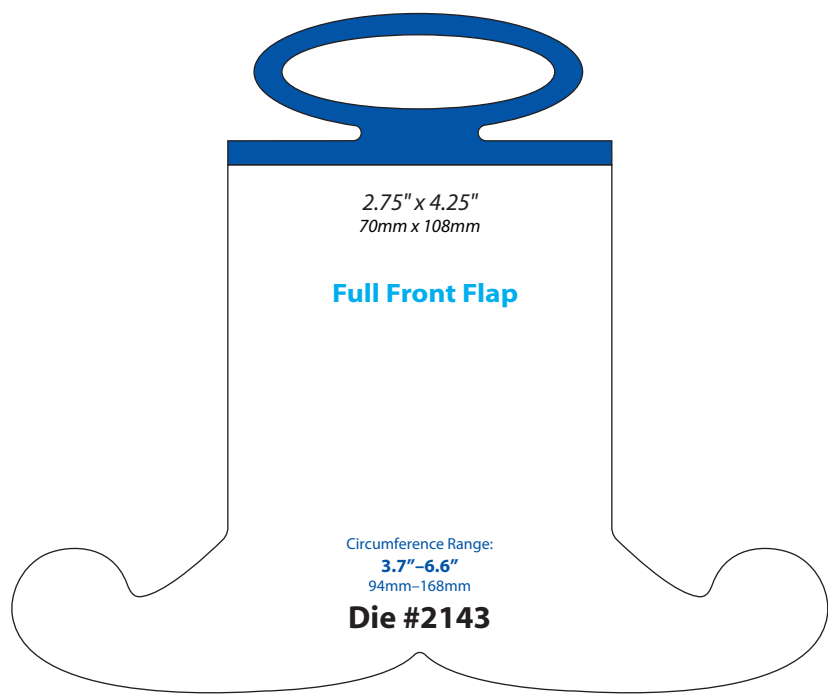

Single/Bifold

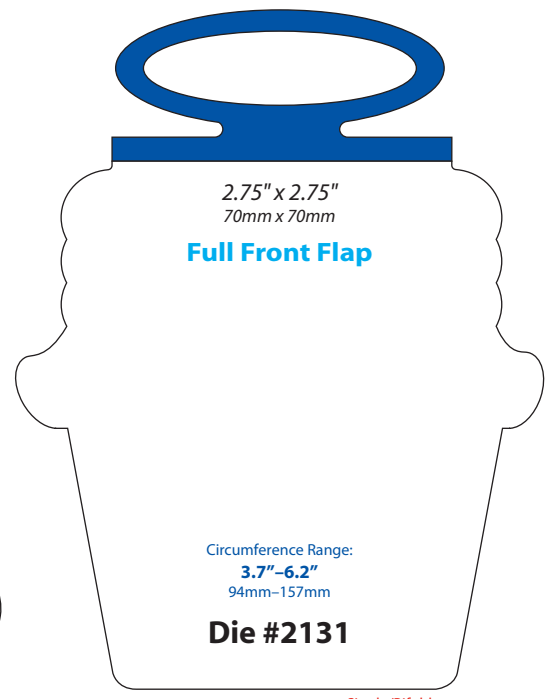

Single/Bifold

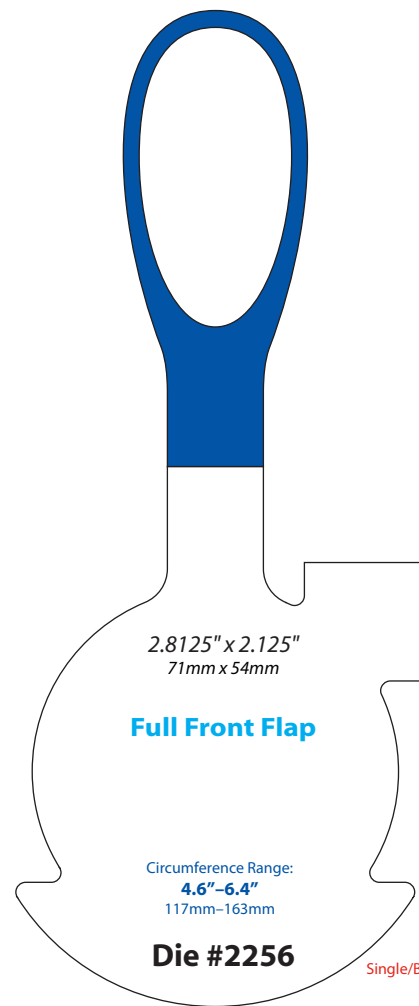

Single/Bifold

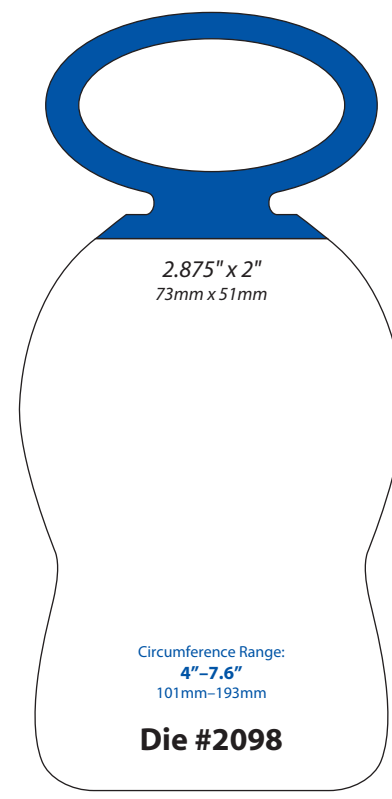

Single/Bifold

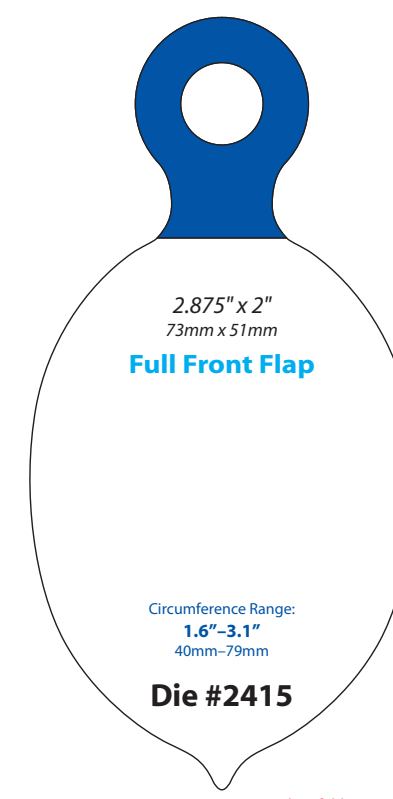

Single/Bifold

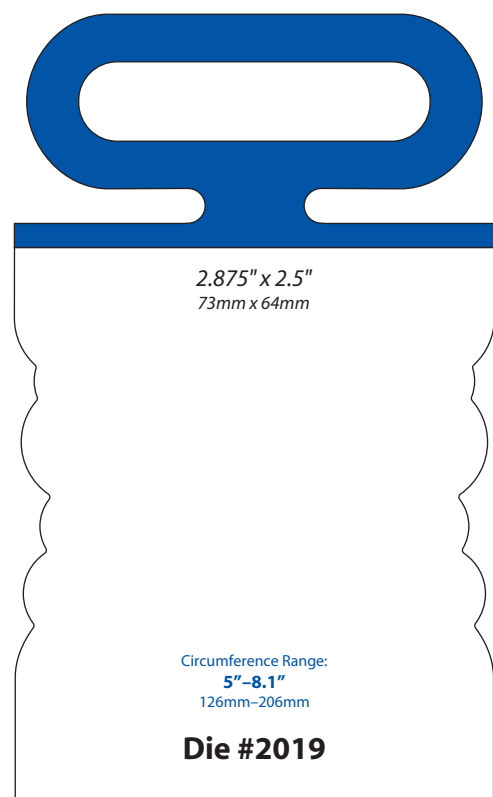

Single

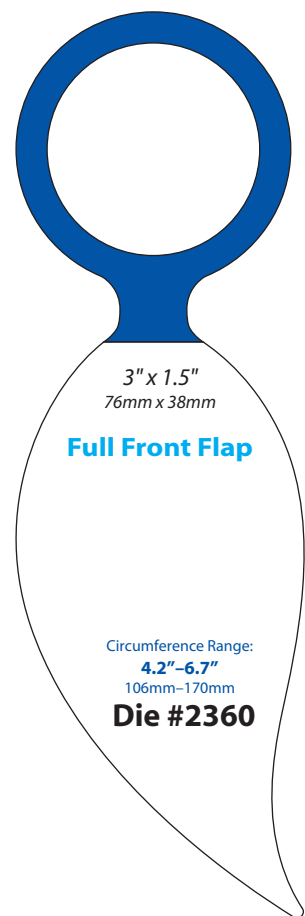

Single/Bifold

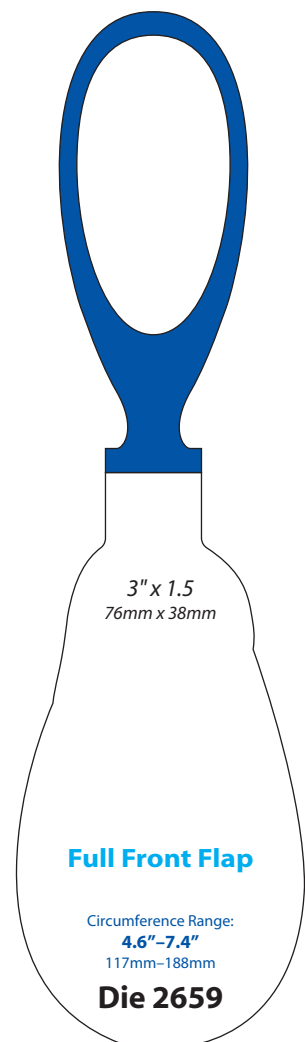

Single/Bifold

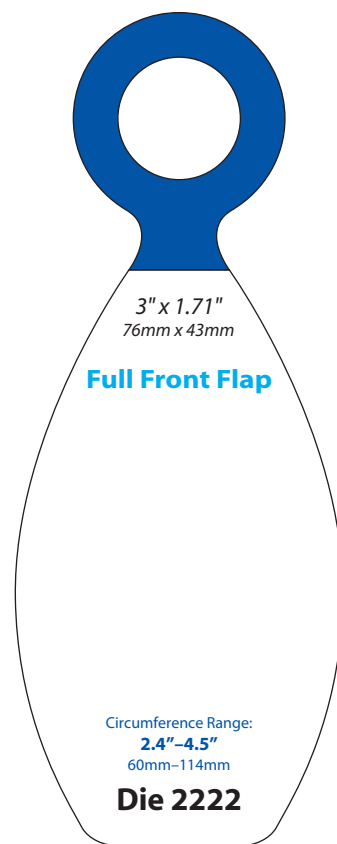

Single/Bifold

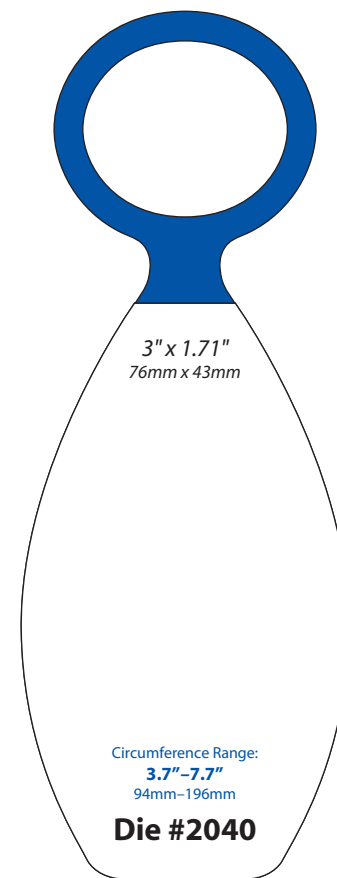

Single/Bifold

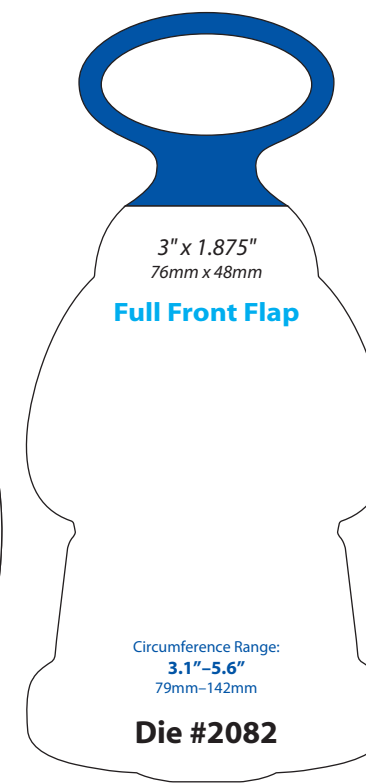

Single/Bifold

- 2019
- 2040
- 2082
- 2098
- 2131
- 2143
- 2222
- 2256
- 2360
- 2415
- 2659

Allows background images to bleed

NON-MATRIX

SPOOLED

P.O.D. SPOOLED

TOTE

MATRIX

MULTIPANEL

NF SPOOLED

TAB

DUO

- 2022
- 2132
- 2177
- 2226
- 2259
- 2320
- 2421
- 2460
- 2477
- 2660
- 2715

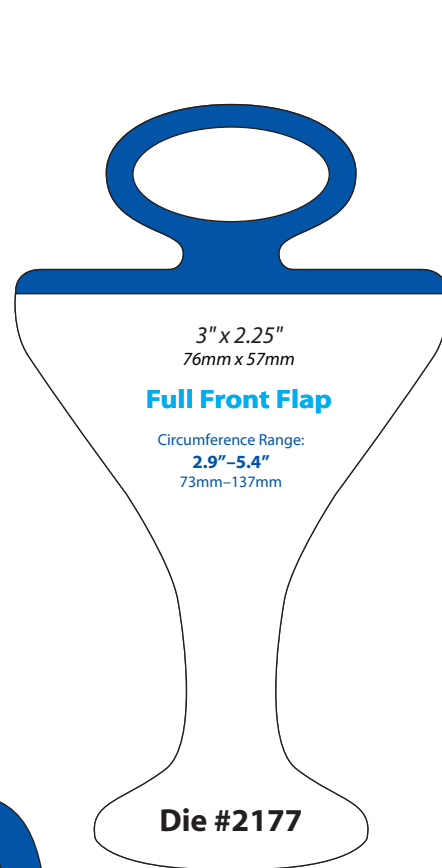

Single/Bifold

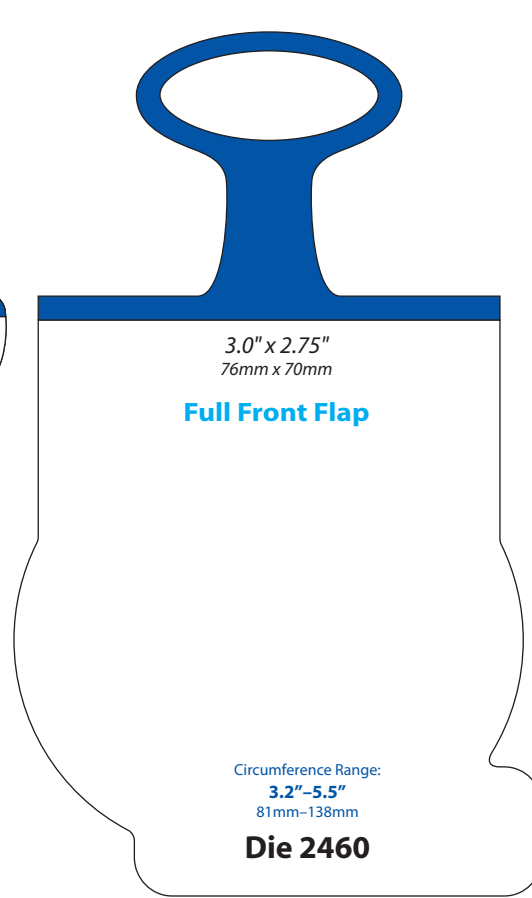

Single/Bifold

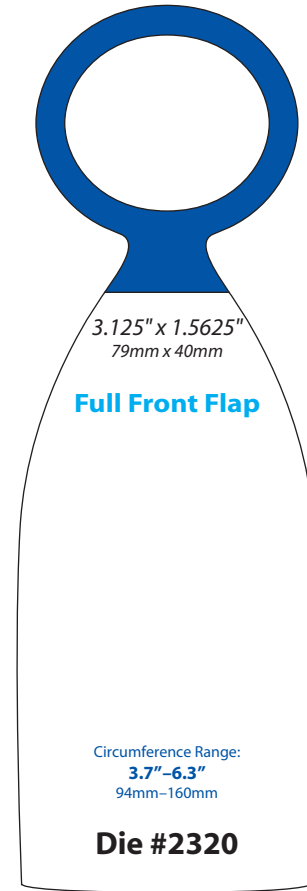

Single/Bifold

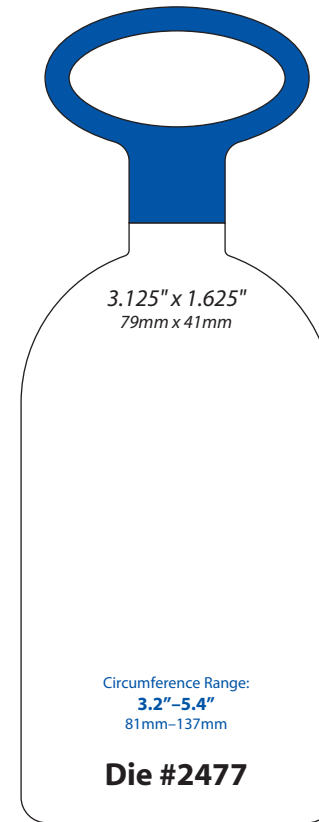

Single

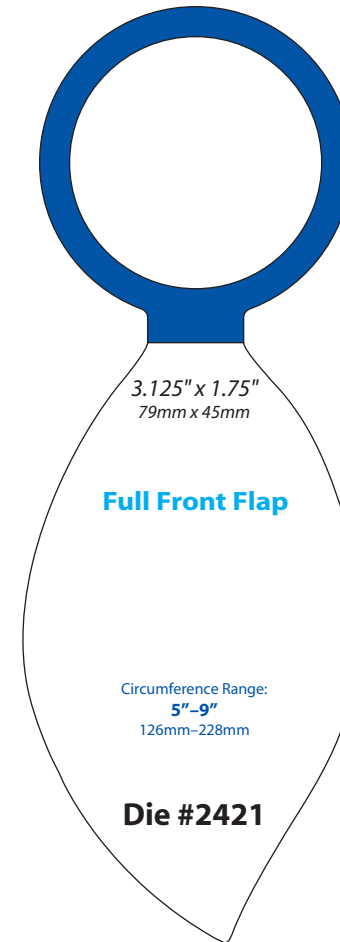

Single/Bifold

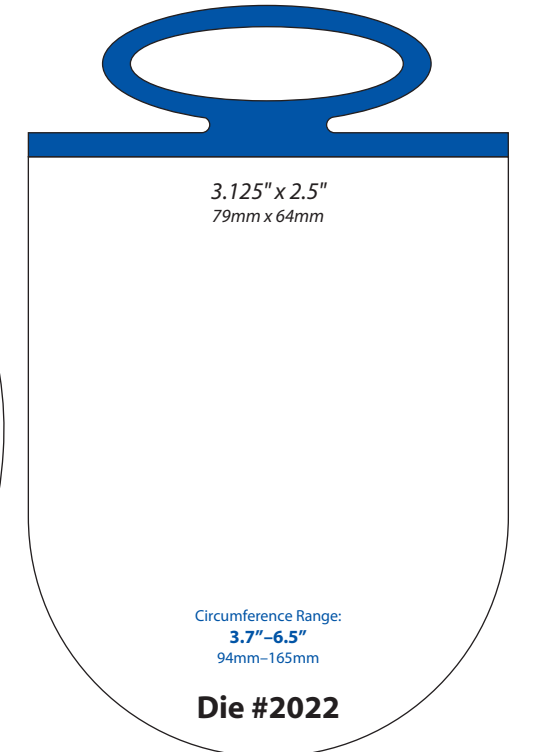

Single/Bifold

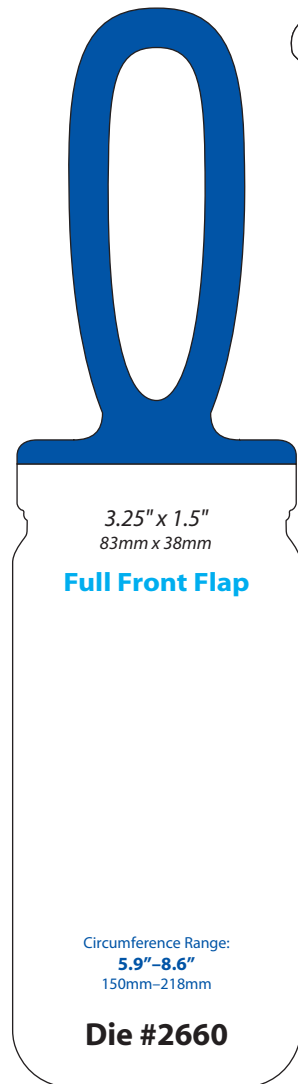

Single/Bifold

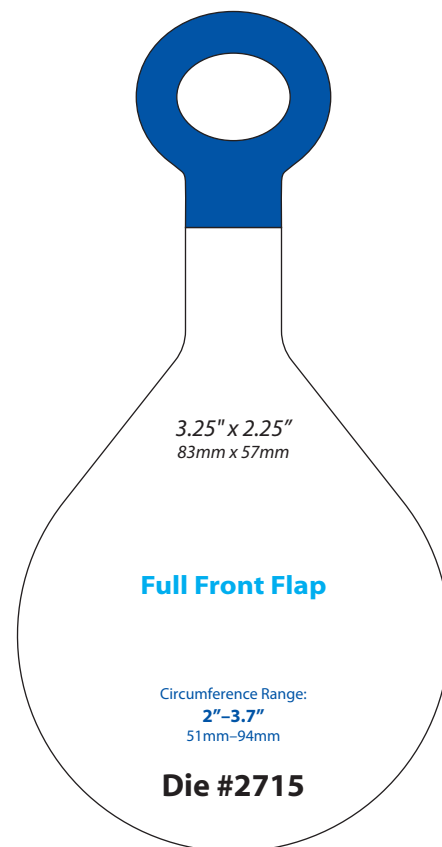

Single/Bifold

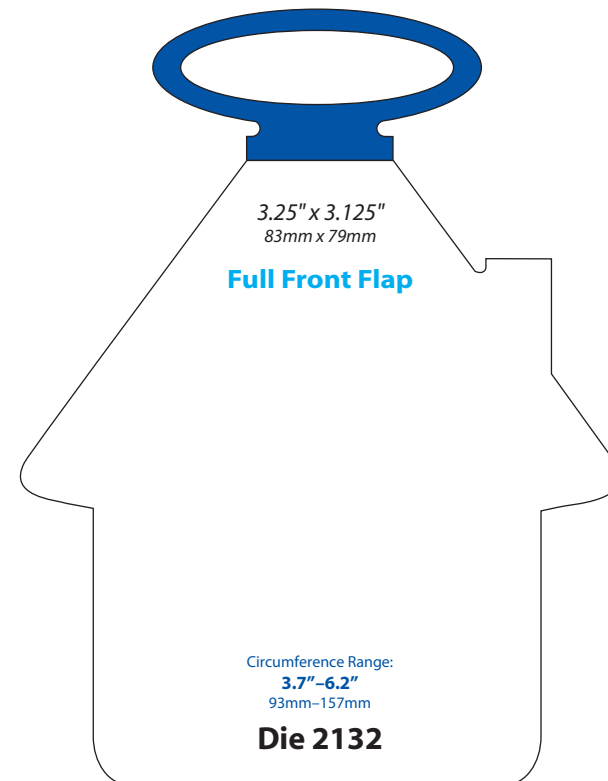

Single/Bifold

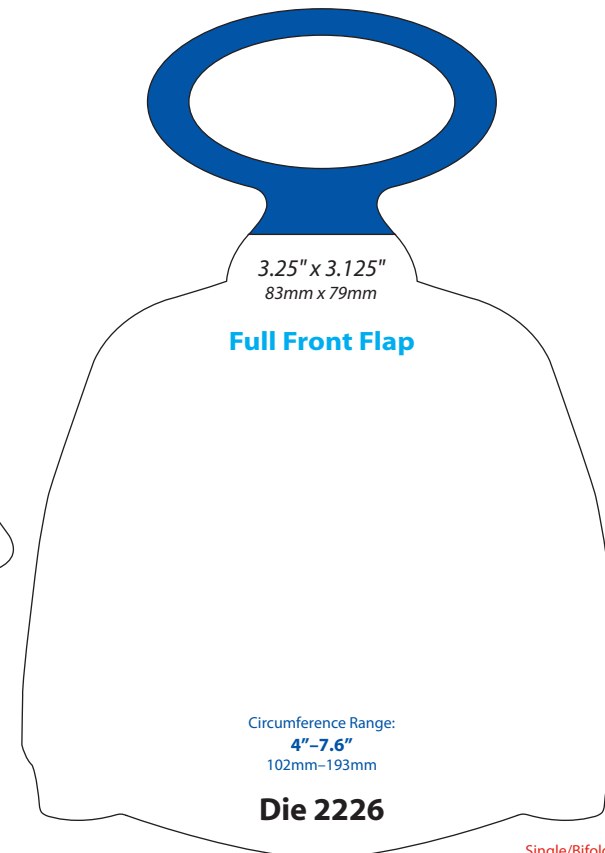

Single/Bifold

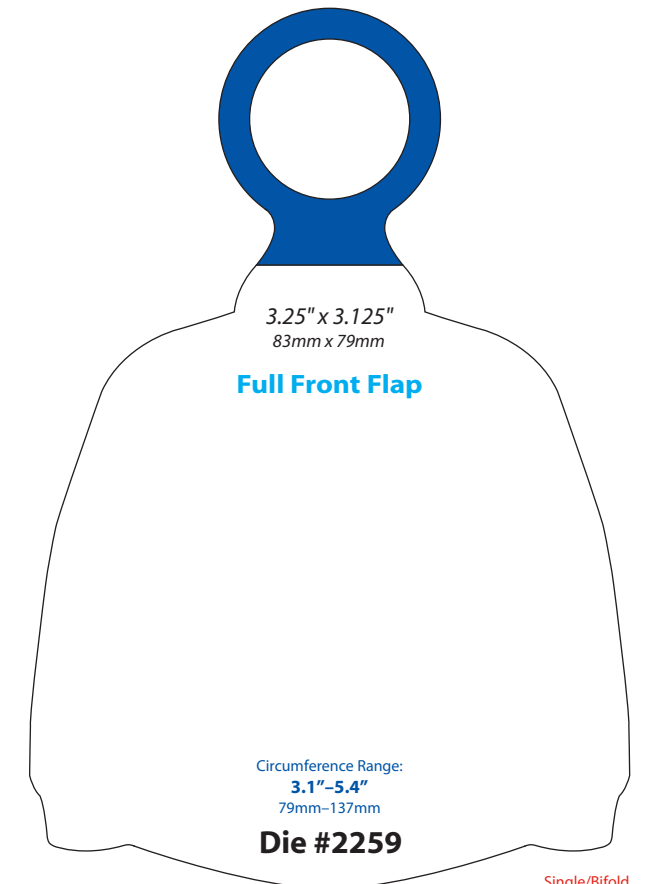

Single/Bifold

Allows background images to bleed

- NON-MATRIX
- SPOOLED
- P.O.D. SPOOLED
- TOTE
- MATRIX**
- MULTIPANEL
- NF SPOOLED
- TAB
- DUO

**ElastiTag**  
BY BEDFORD

Updated: 08/01/23

Patent: elastitag.com/patents



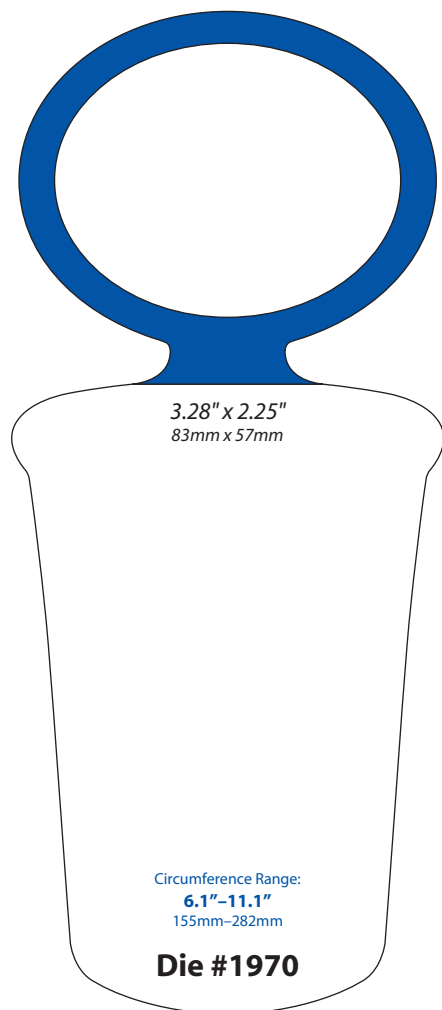

Single/Bifold

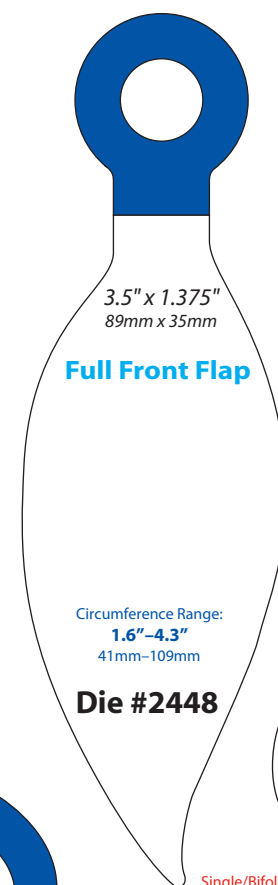

Single/Bifold

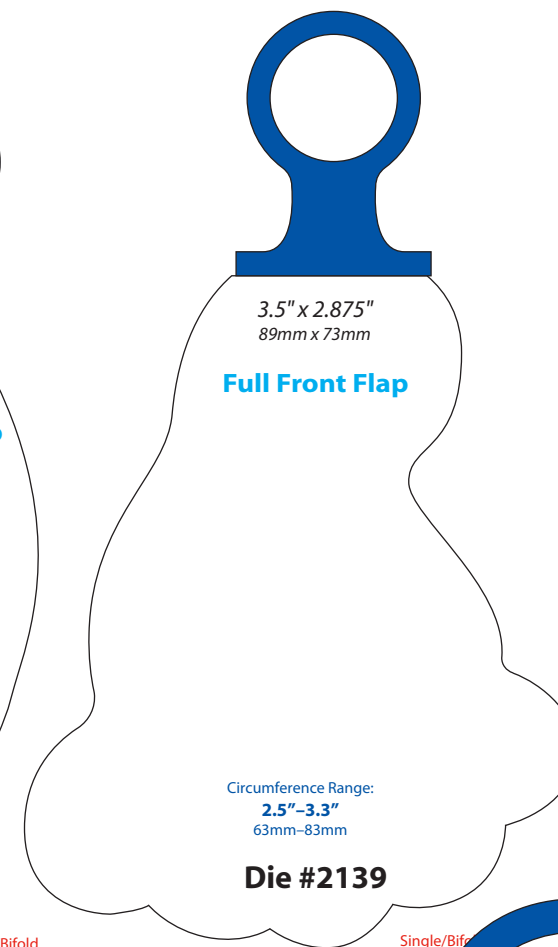

Single/Bifold

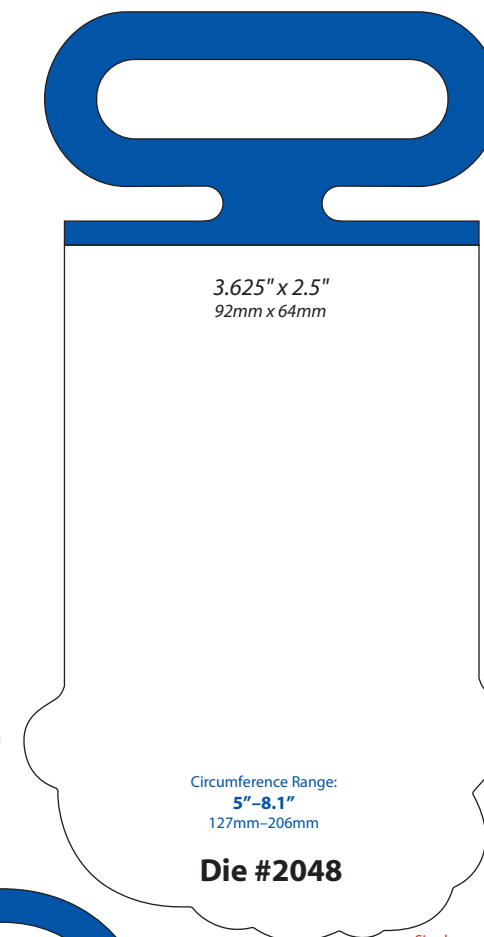

Single

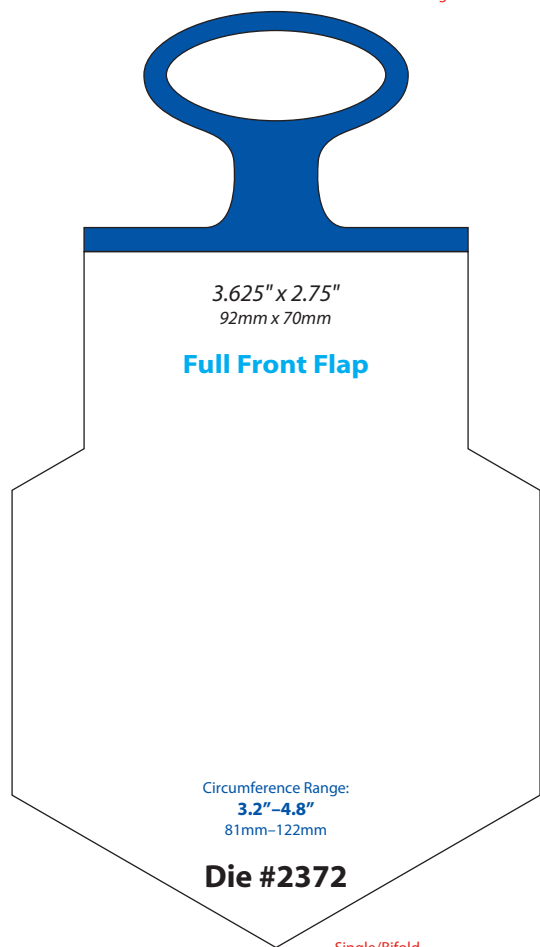

Single/Bifold

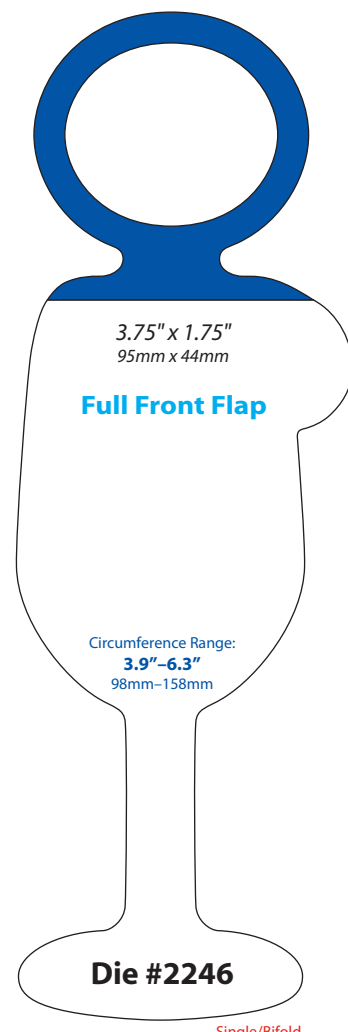

Single/Bifold

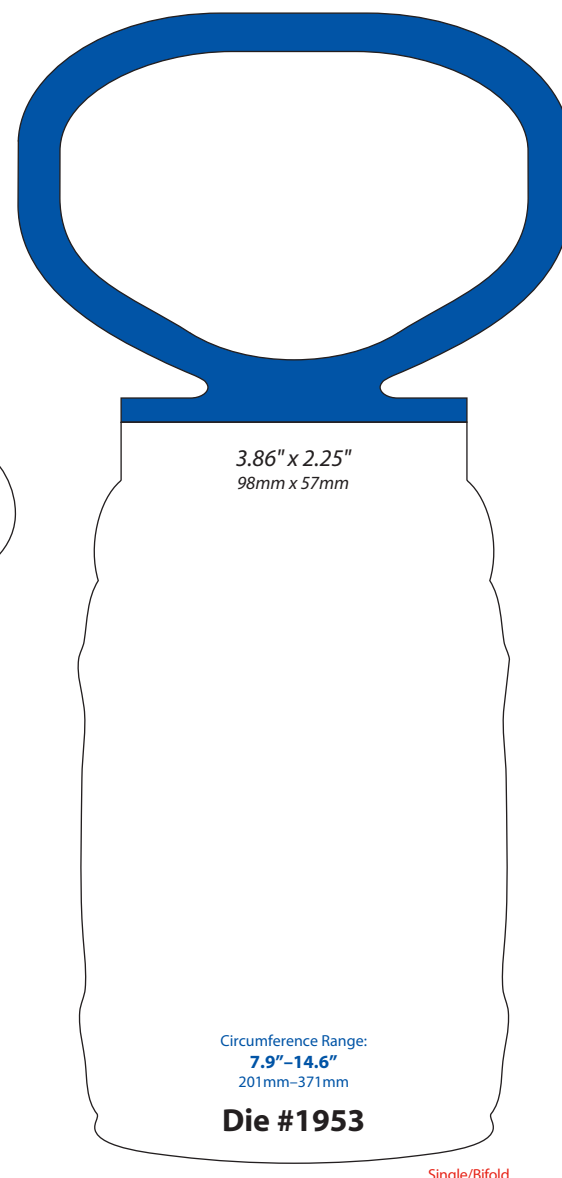

Single/Bifold

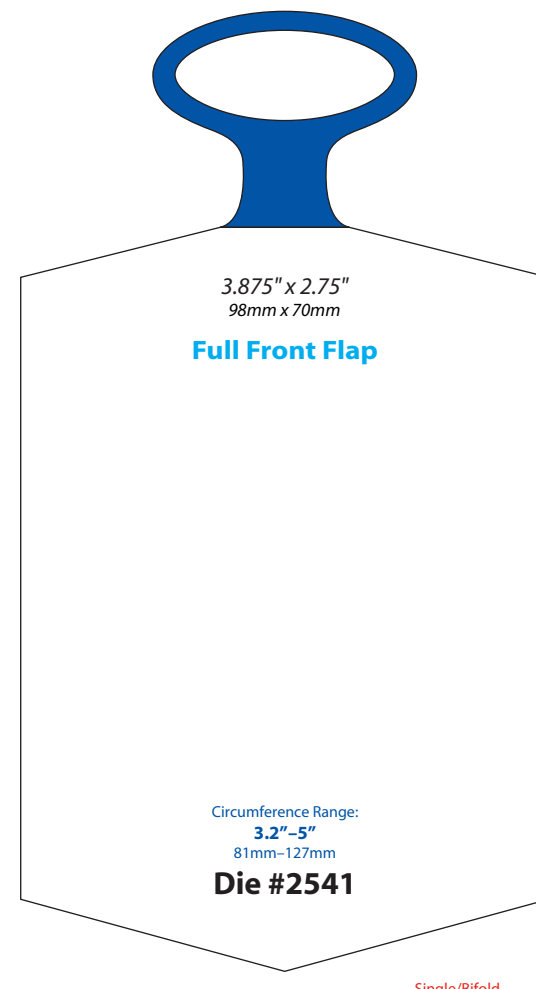

Single/Bifold

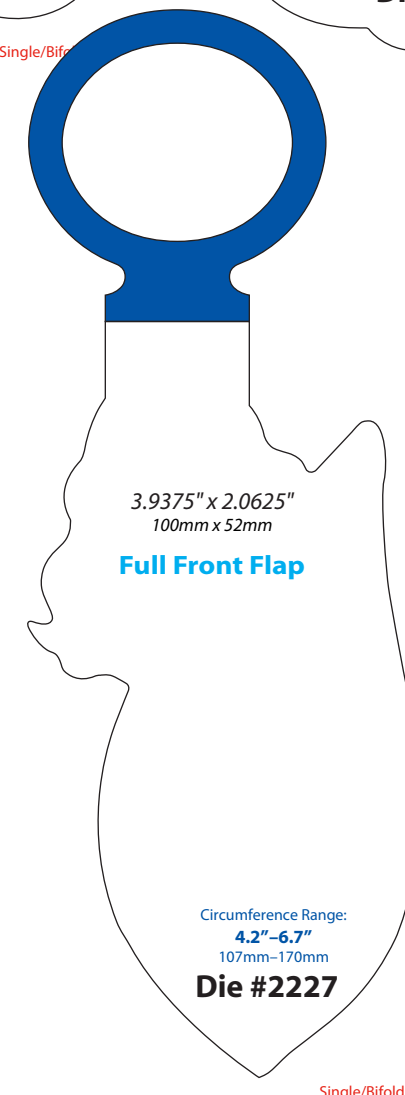

Single/Bifold

- 1953
- 1970
- 2048
- 2139
- 2227
- 2246
- 2372
- 2448
- 2541

Allows background images to bleed

- NON-MATRIX
- SPOOLED
- P.O.D. SPOOLED
- TOTE
- MATRIX**
- MULTIPANEL
- NF SPOOLED
- TAB
- DUO

2013

2261

2293

2384

2438

2625

Allows background images to bleed

NON-MATRIX

SPOOLED

P.O.D. SPOOLED

TOTE

MATRIX

MULTIPANEL

NF SPOOLED

TAB

DUO

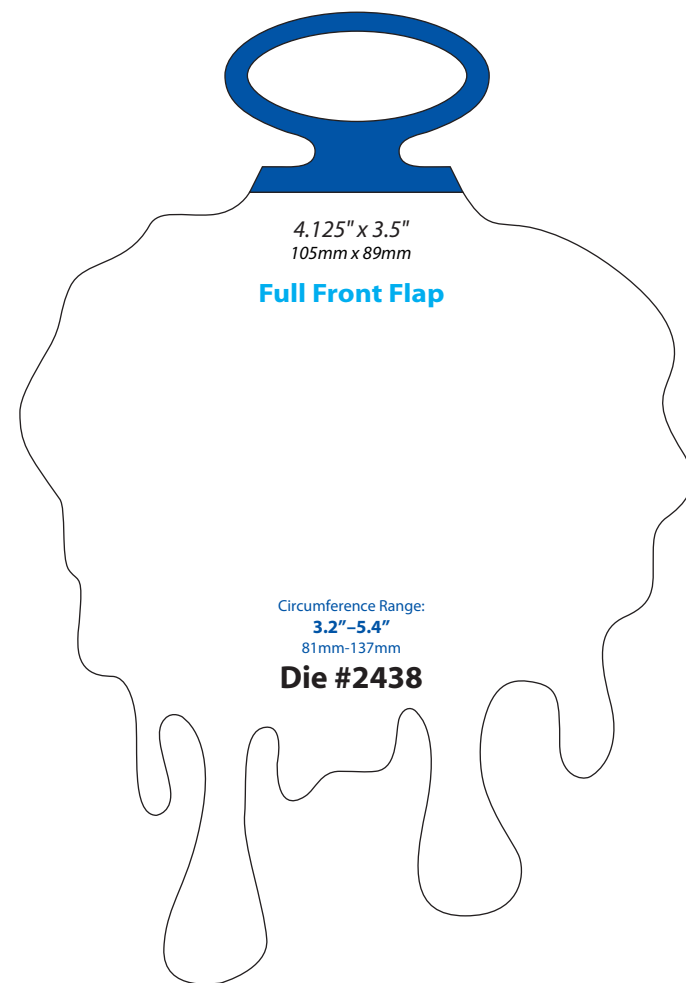

Single/Bifold



Single/Bifold

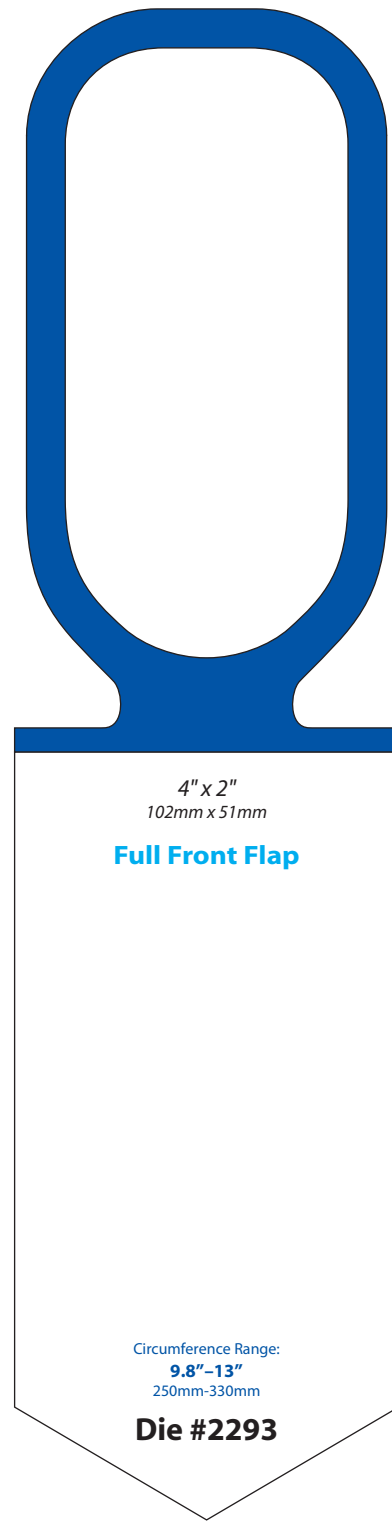

Single/Bifold

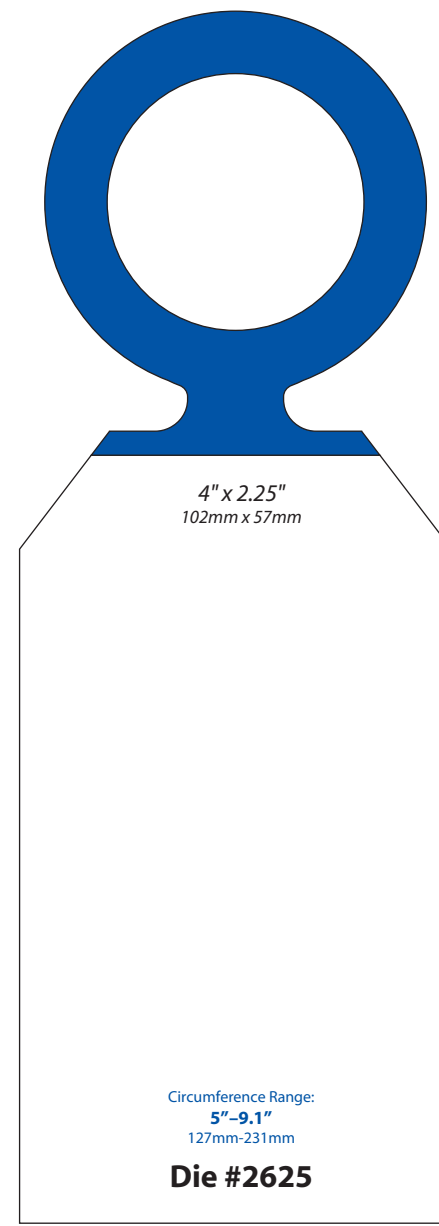

Single

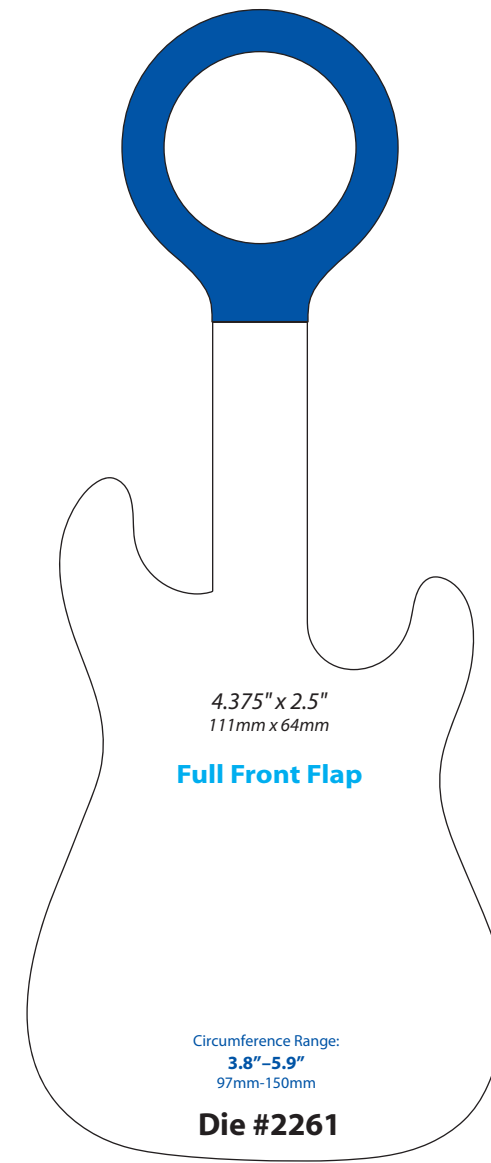

Single/Bifold

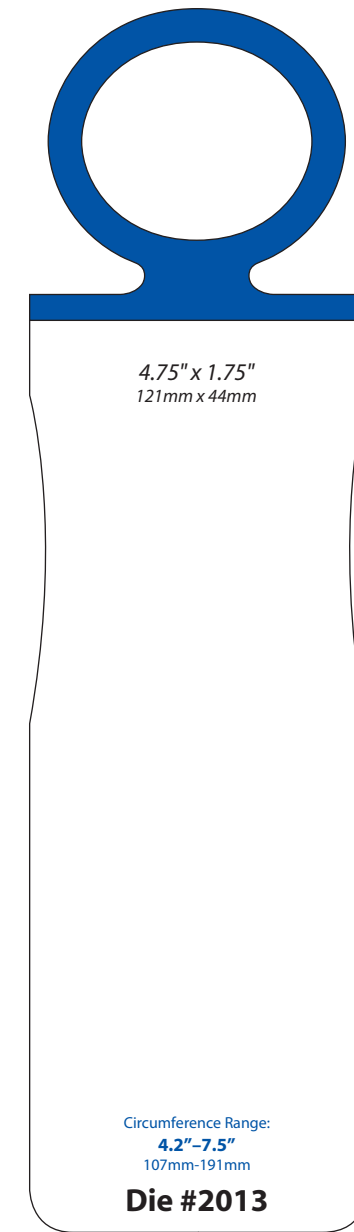

Single/Bifold

2245  
2333  
2479

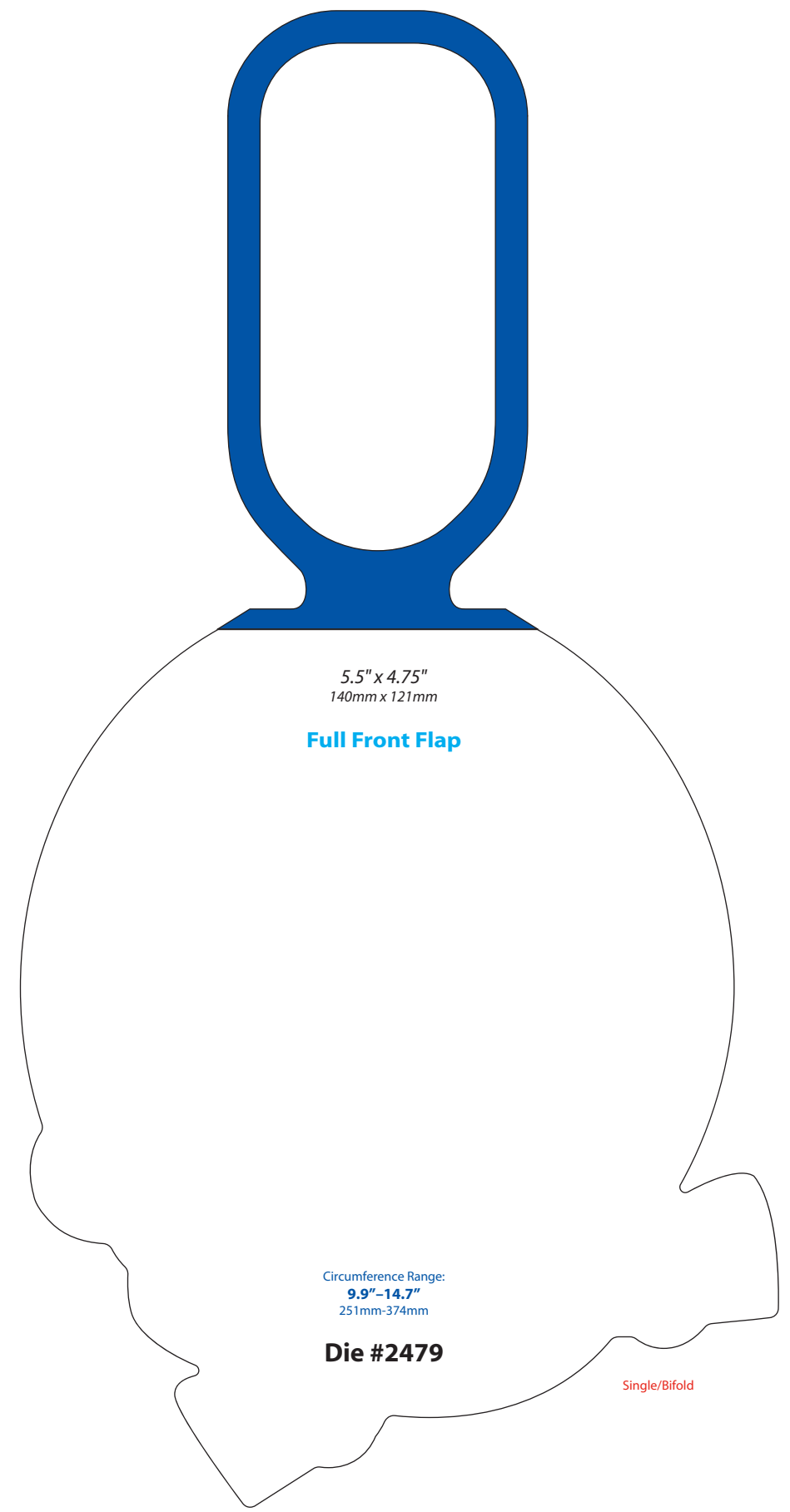
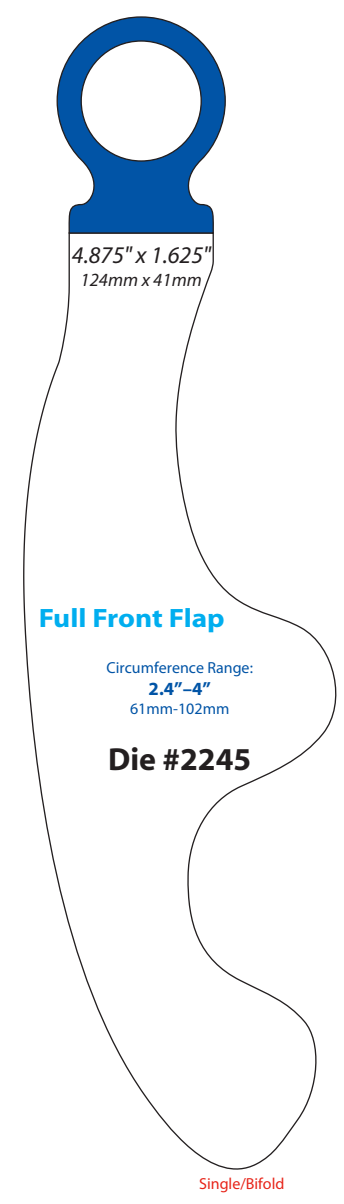
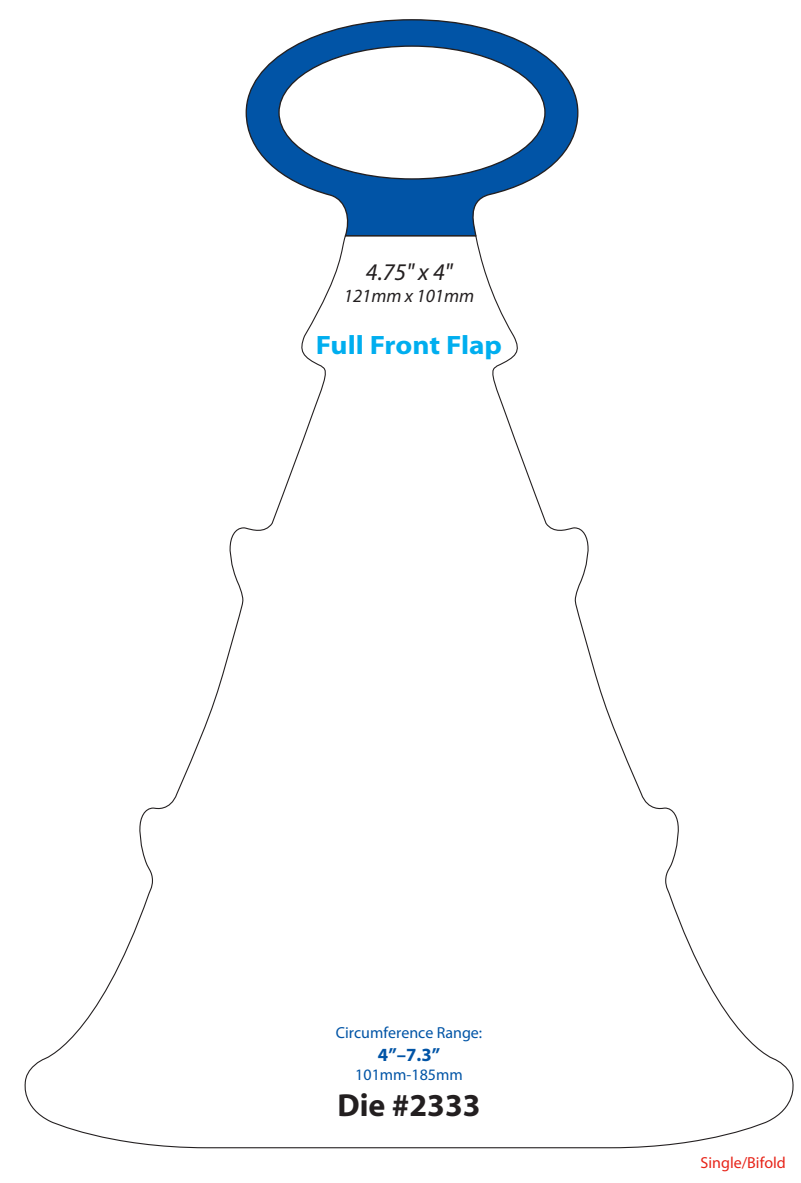

Allows background images to bleed

- NON-MATRIX
- SPOOLED
- P.O.D. SPOOLED
- TOTE
- MATRIX**
- MULTIPANEL
- NF SPOOLED
- TAB
- DUO

- 2367
- 2368
- 2387
- 2418
- 2455
- 2480
- 2537
- 2538
- 2539

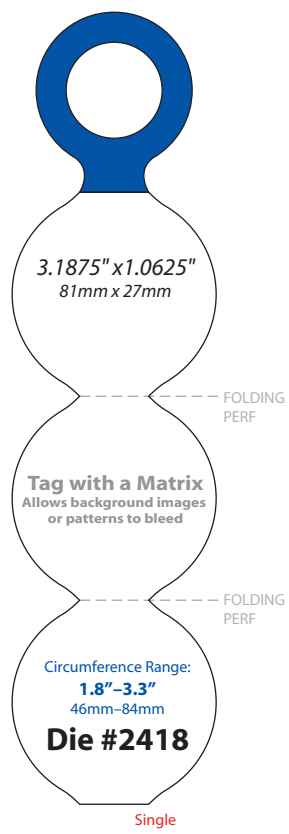

Single

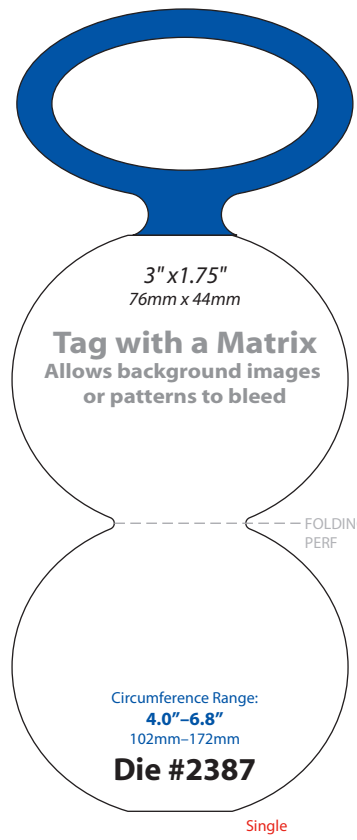

Single

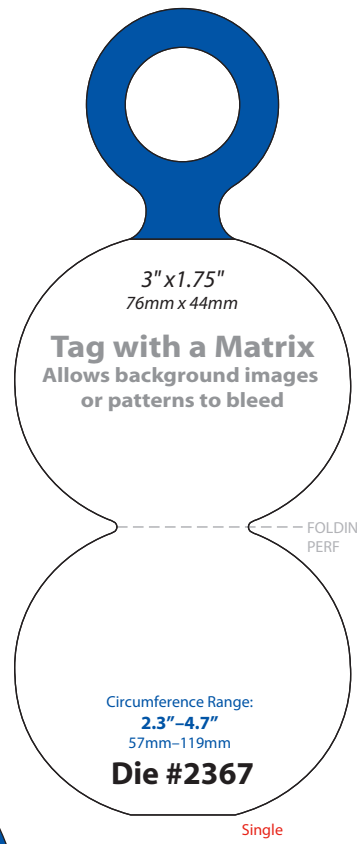

Single

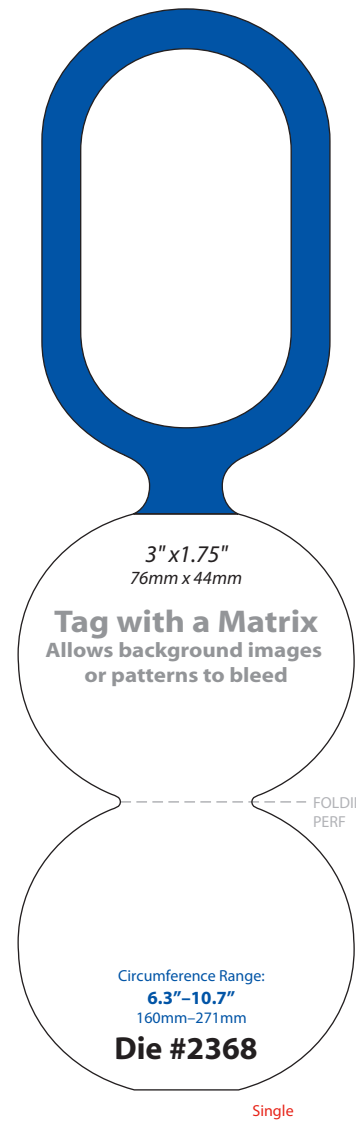

Single

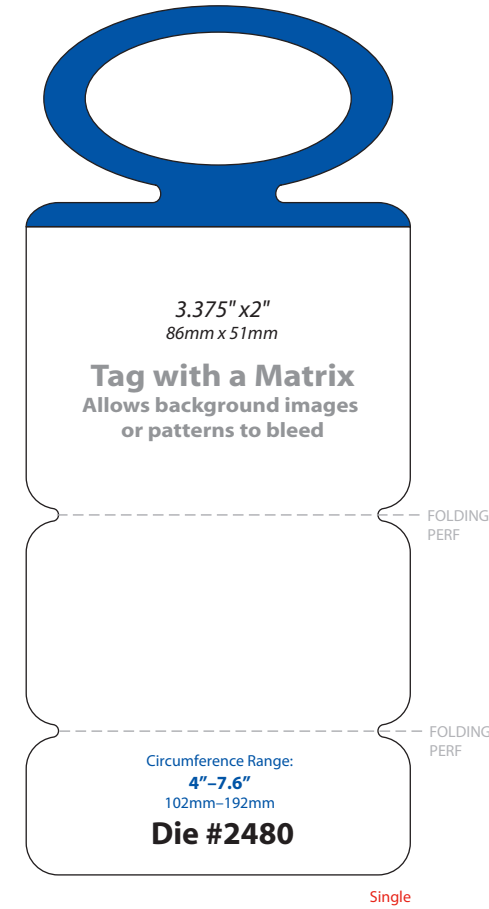

Single

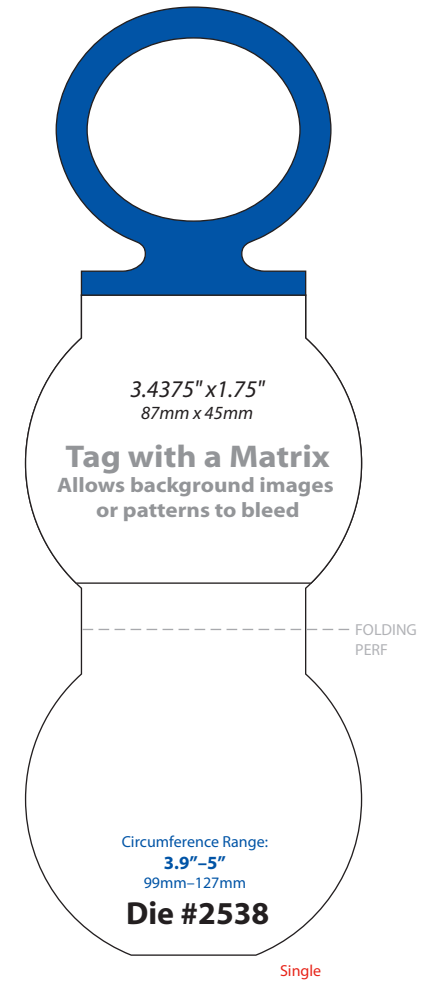

Single

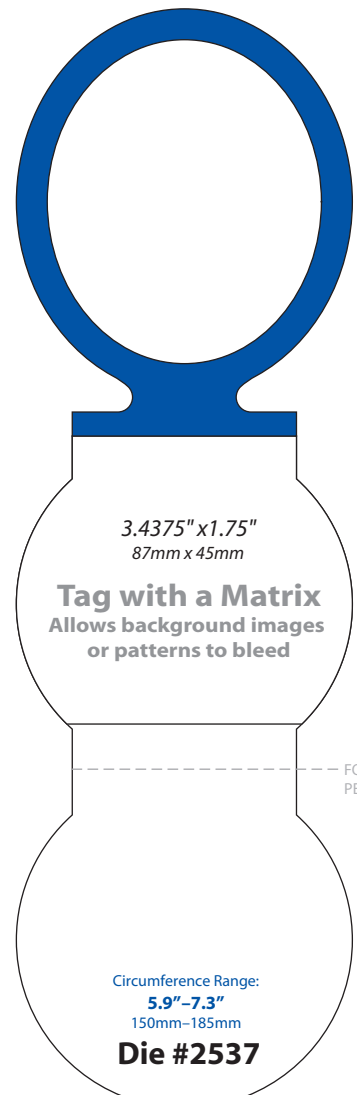

Single



Single

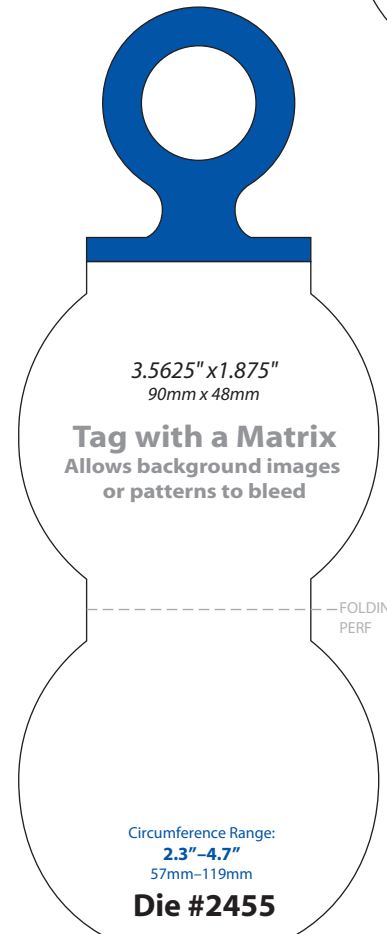

Single

- NON-MATRIX
- SPOOLED
- P.O.D. SPOOLED
- TOTE
- MATRIX
- MULTIPANEL
- NF SPOOLED
- TAB
- DUO

- 2356
- 2544
- 2545
- 2546

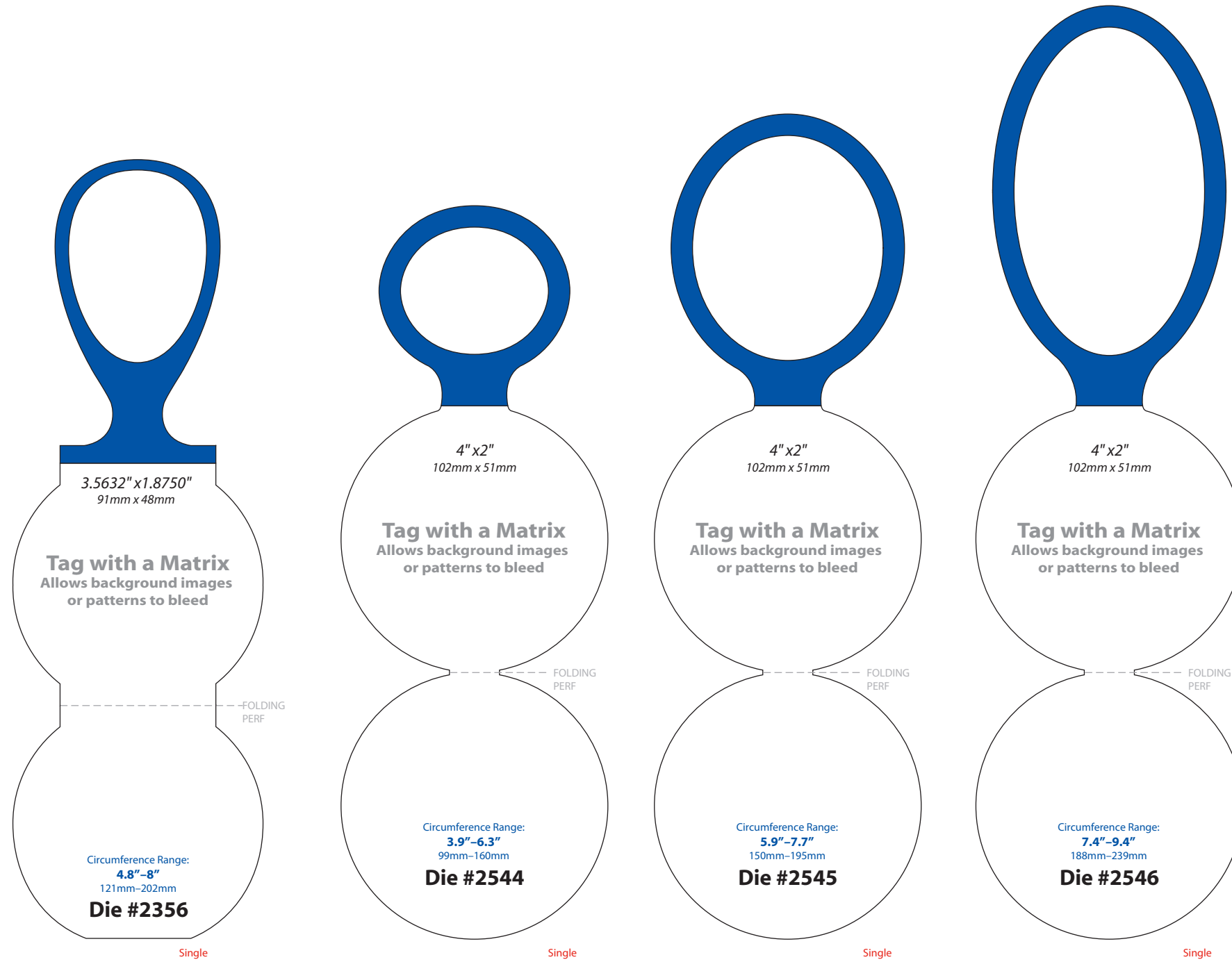

- NON-MATRIX
- SPOOLED
- P.O.D. SPOOLED
- TOTE
- MATRIX
- MULTIPANEL**
- NF SPOOLED
- TAB
- DUO

2080  
2026  
2192  
2302

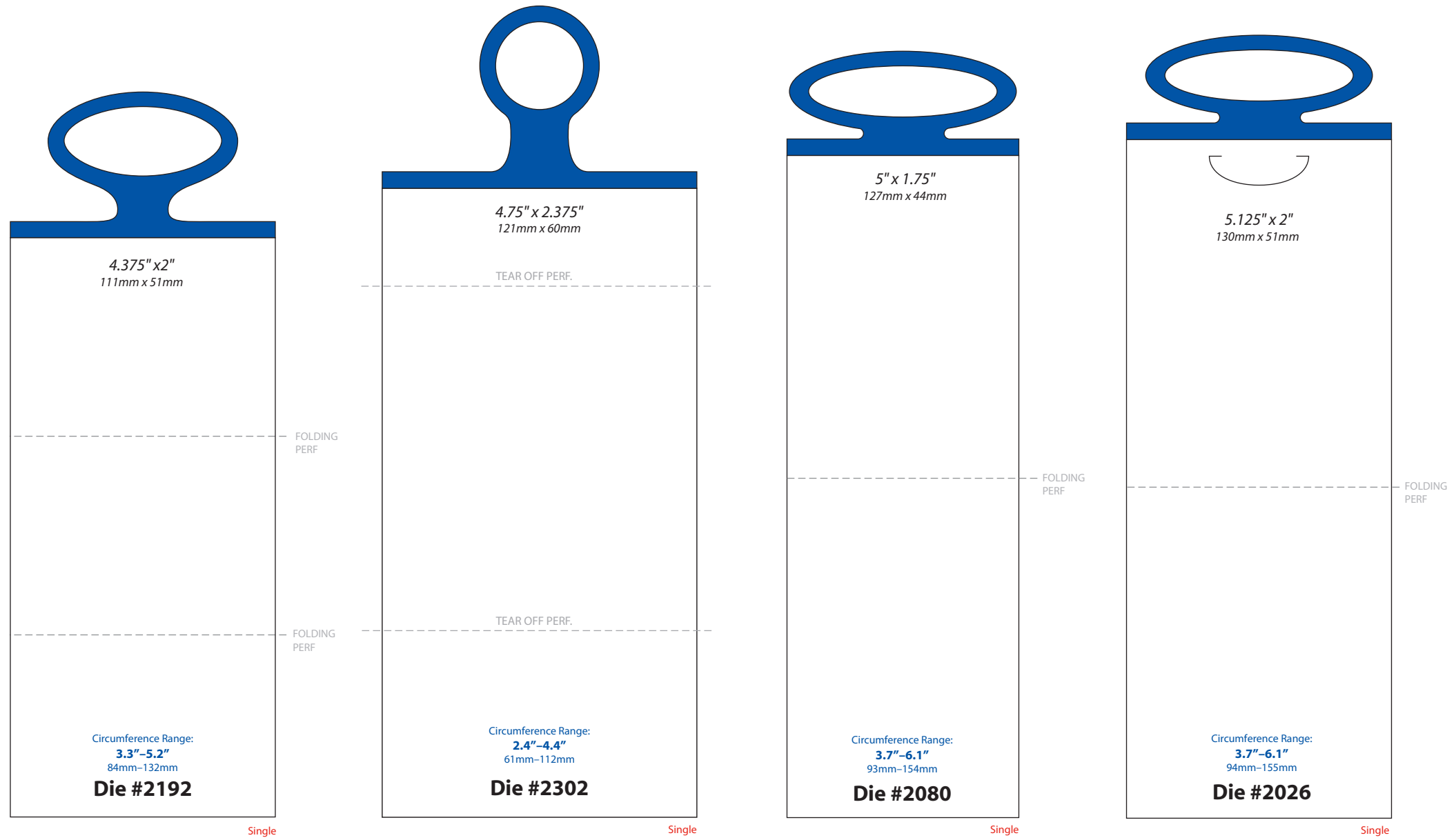

NON-MATRIX  
SPOOLED  
P.O.D. SPOOLED  
TOTE  
MATRIX  
MULTIPANEL  
NF SPOOLED  
TAB  
DUO

- 2059
- 2273
- 2297
- 2339
- 2506

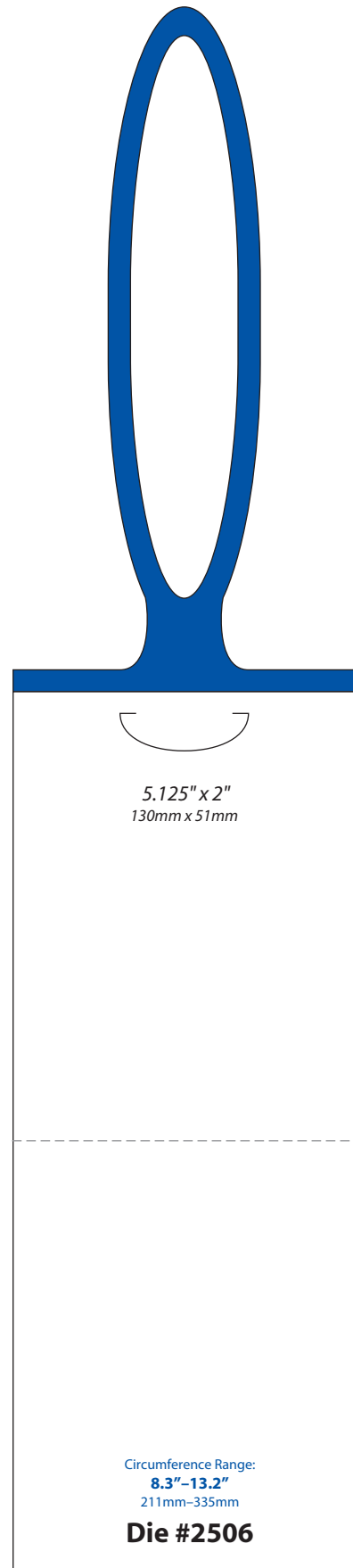

Single



Single

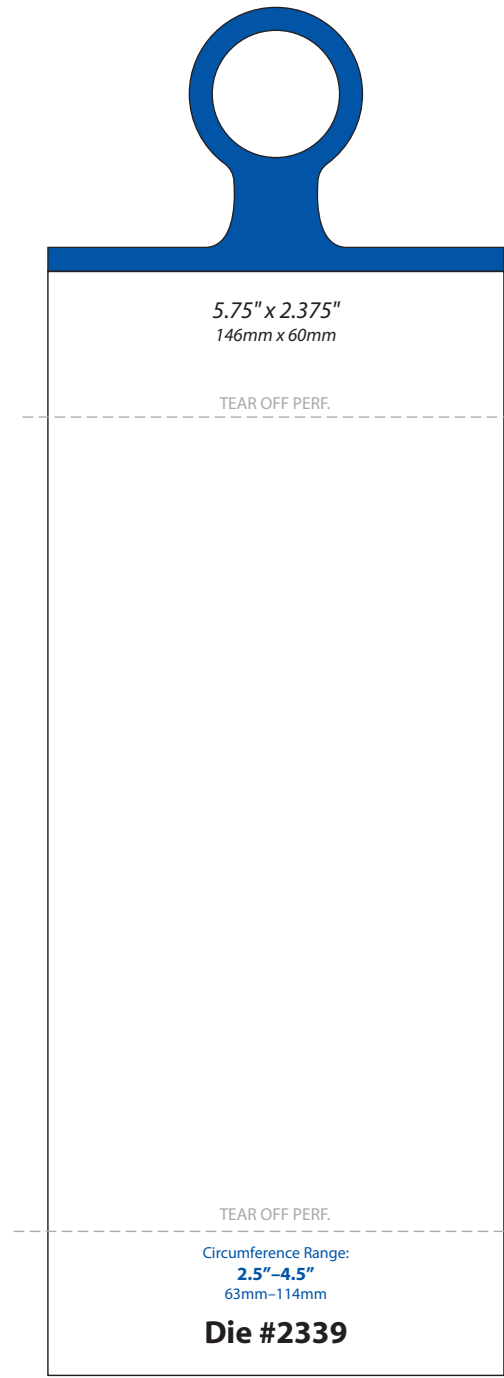

Single

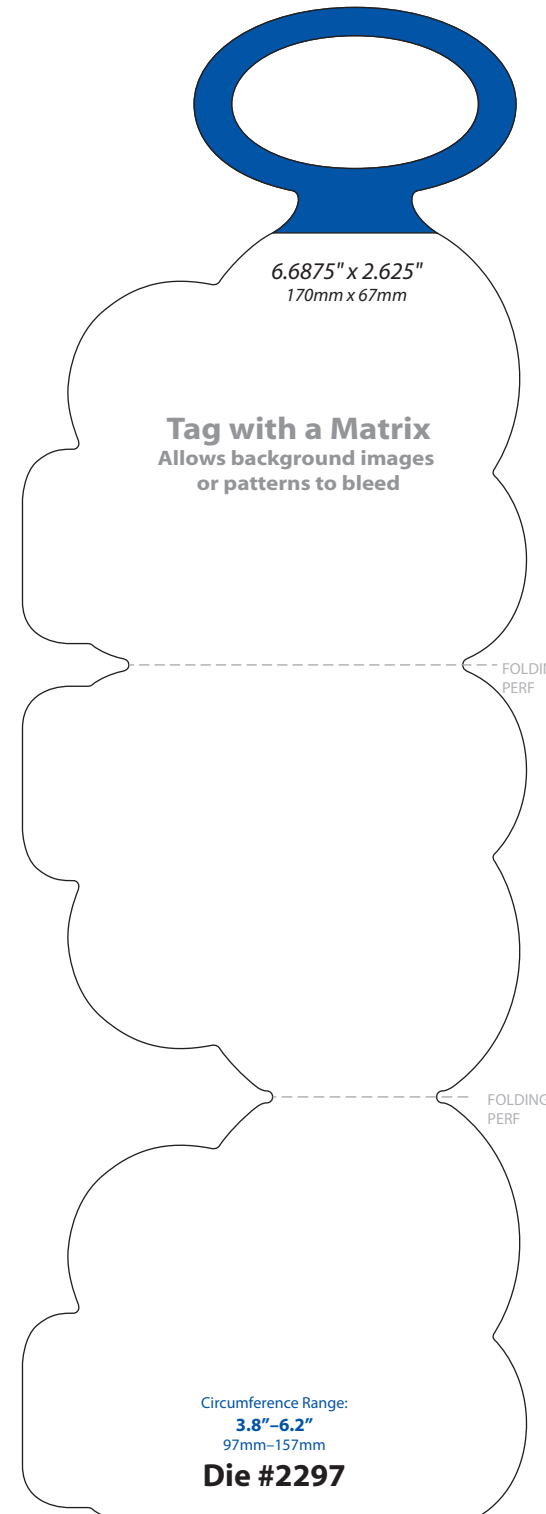

Single

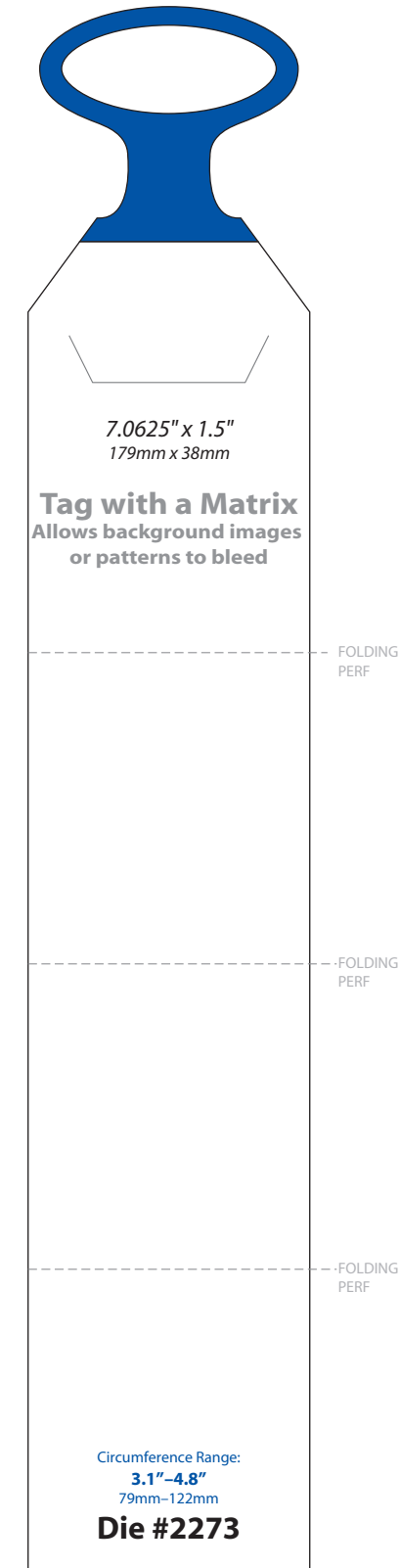

Single

- NON-MATRIX
- SPOOLED
- P.O.D. SPOOLED
- TOTE
- MATRIX
- MULTIPANEL**
- NF SPOOLED
- TAB
- DUO

2060  
2149  
2447  
2558

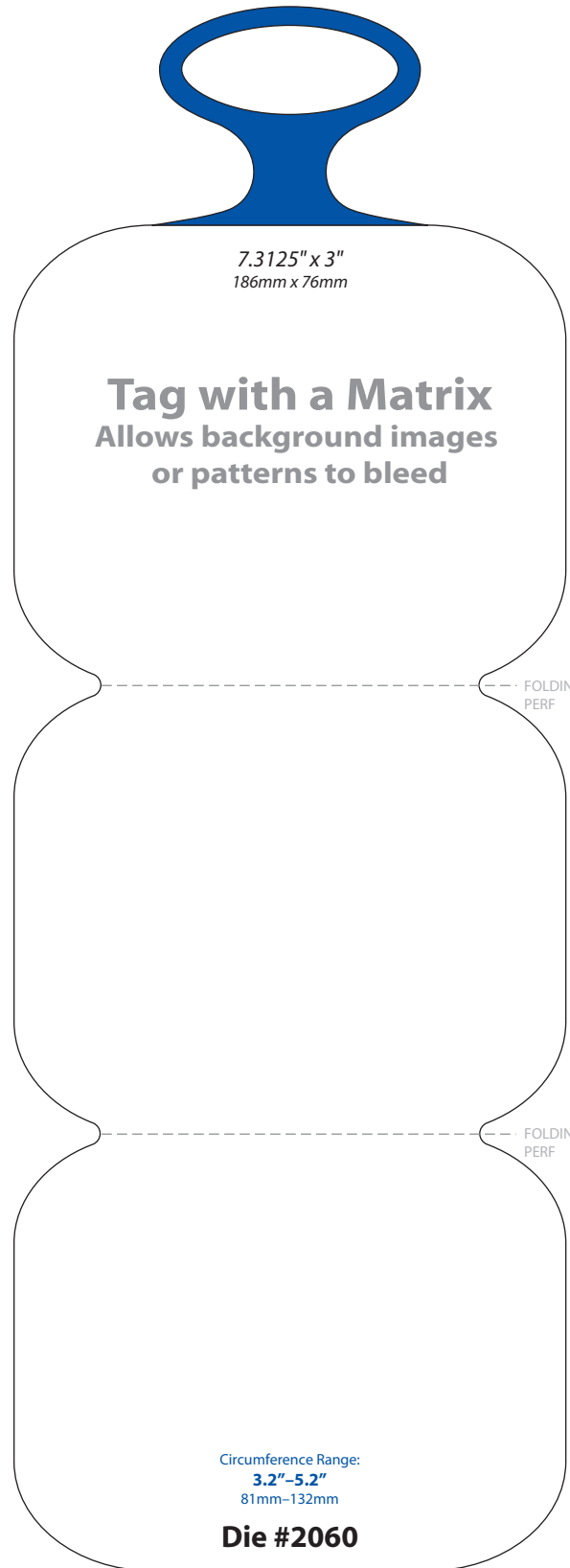

Single

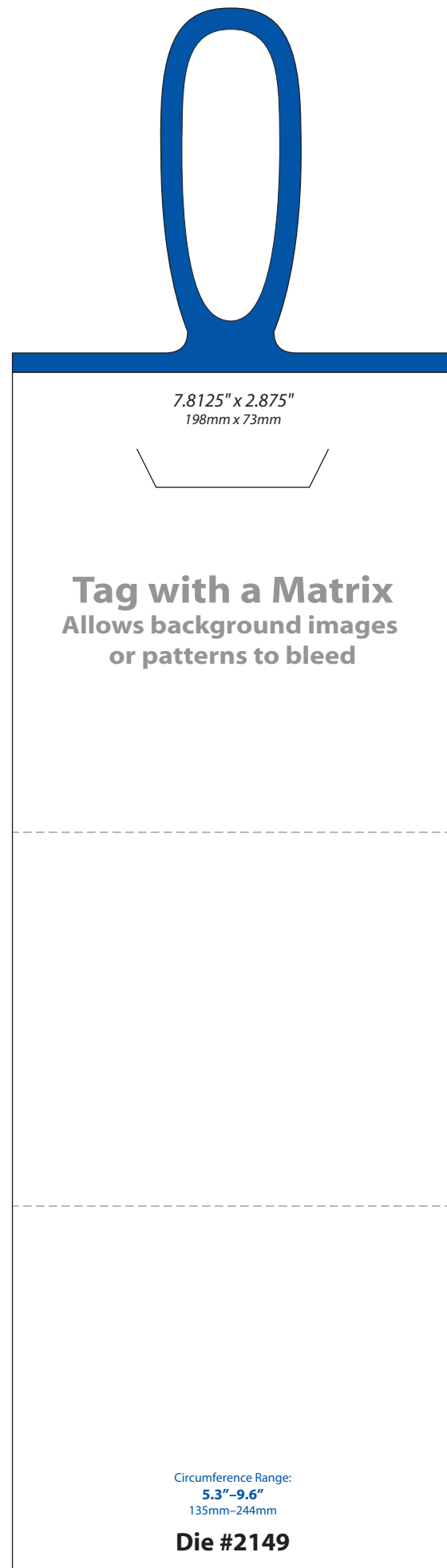

Single

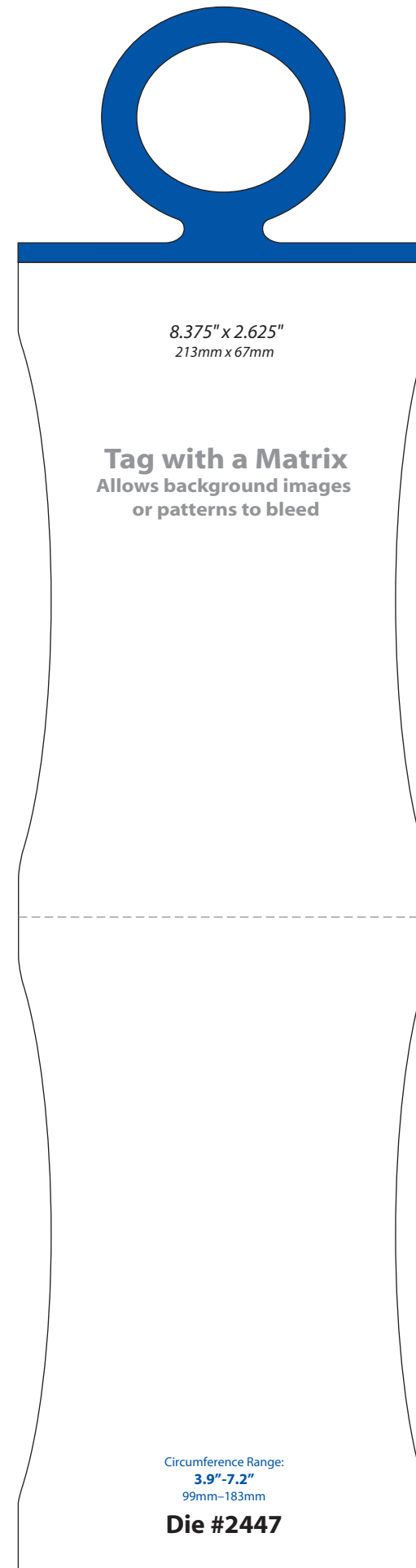

Single

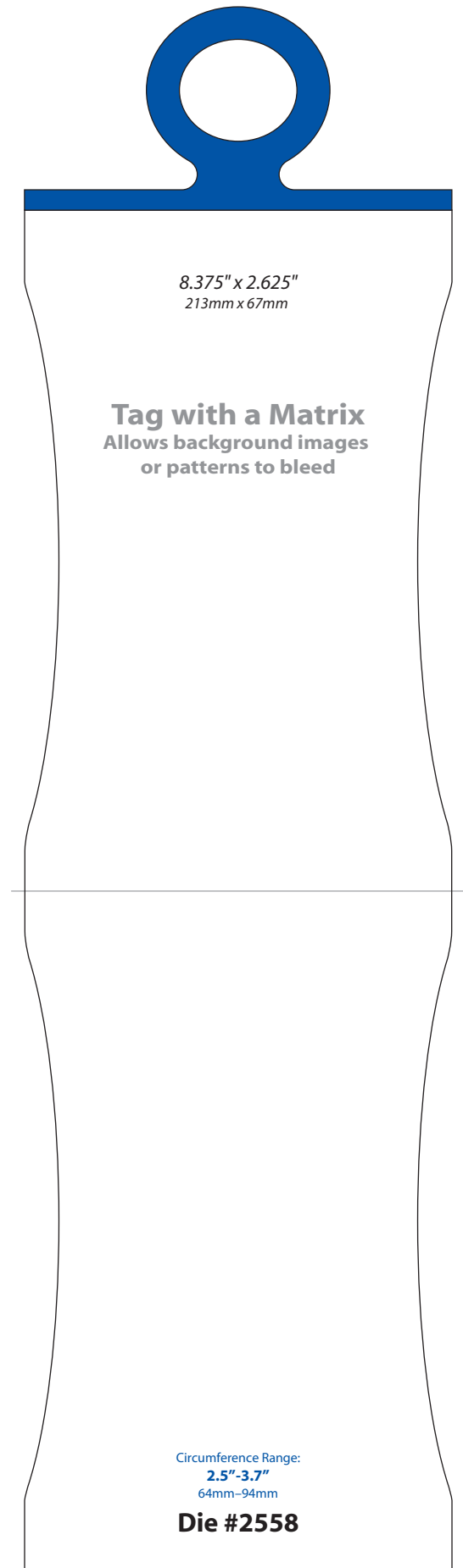

Single

NON-MATRIX  
SPOOLED  
P.O.D. SPOOLED  
TOTE  
MATRIX  
MULTIPANEL  
NF SPOOLED  
TAB  
DUO

ElastiTag®  
BY BEDFORD

Updated: 10/04/21

Patent: elastitag.com/patents



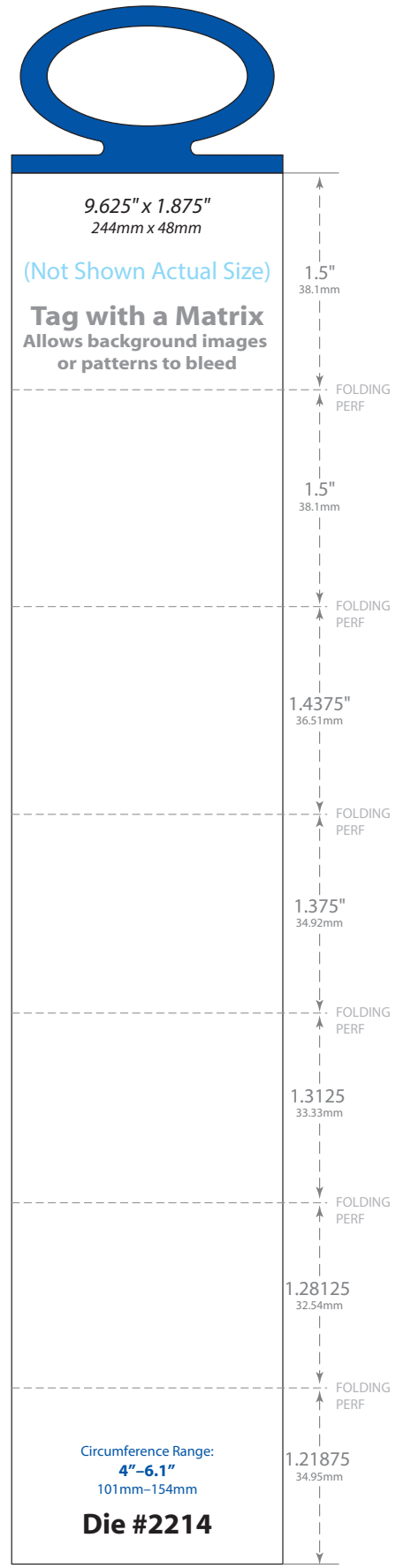
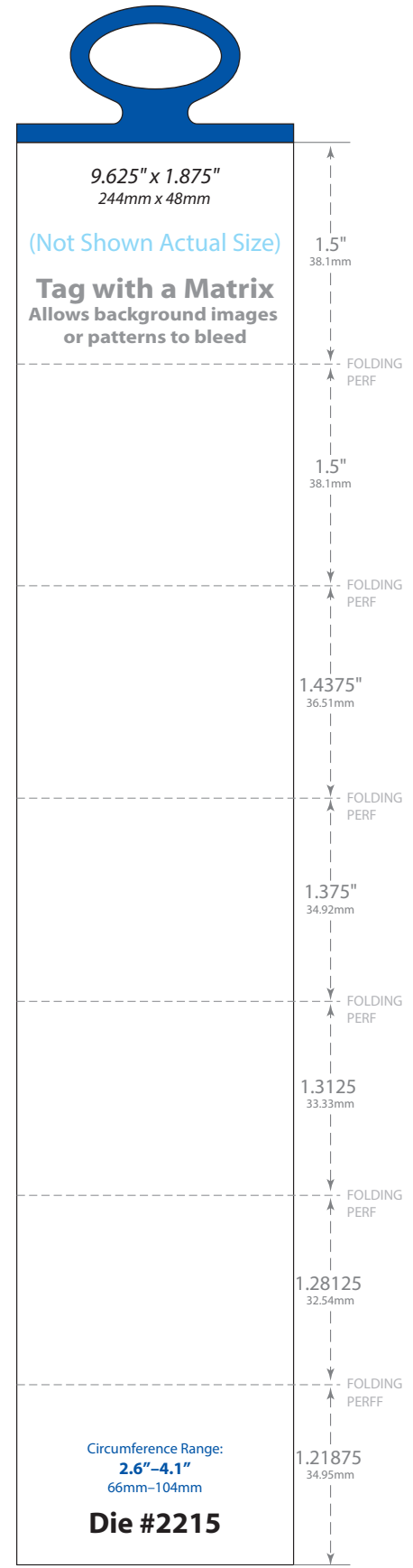
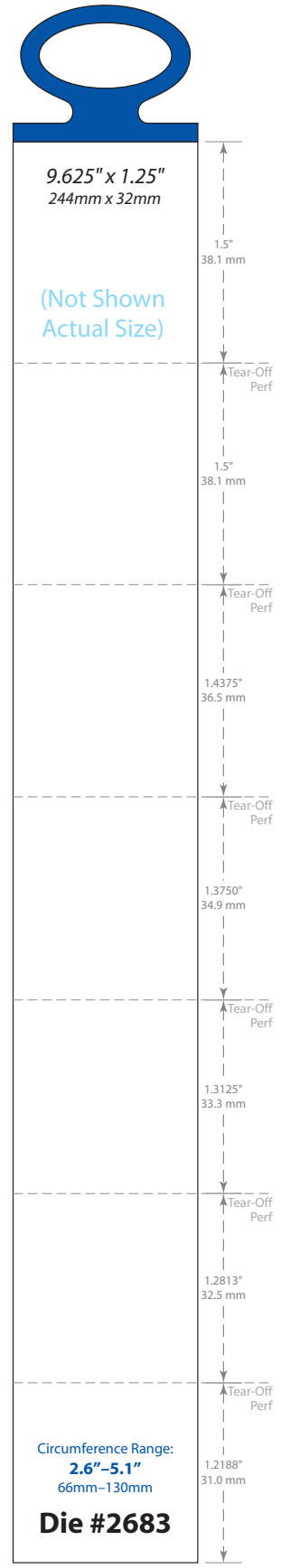
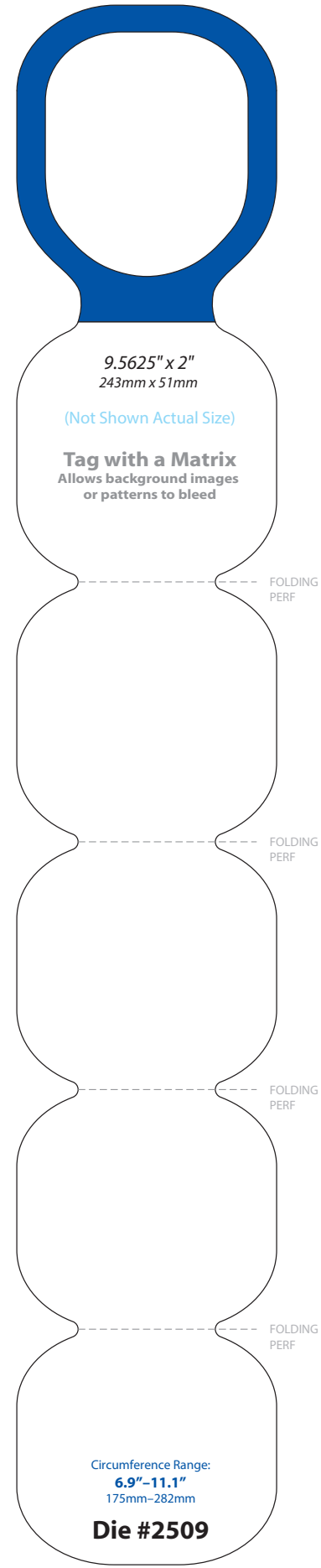
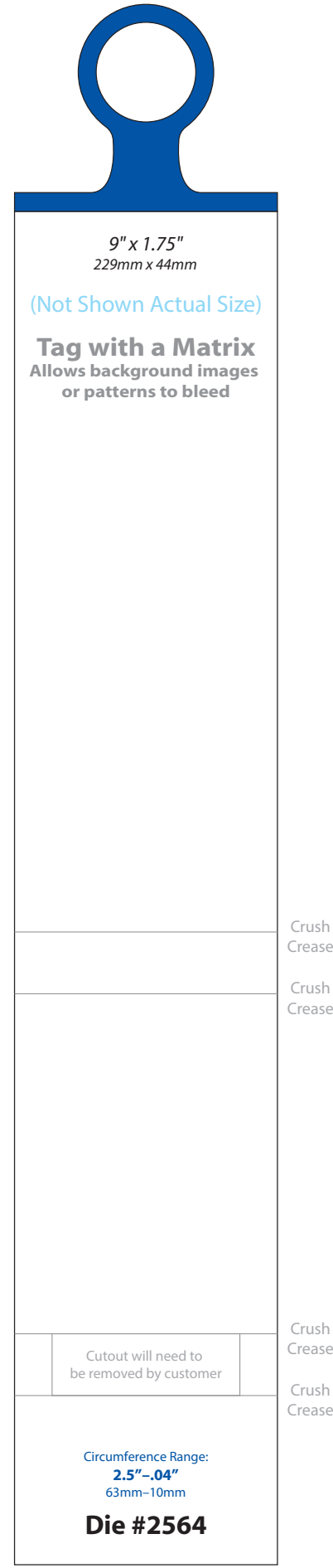
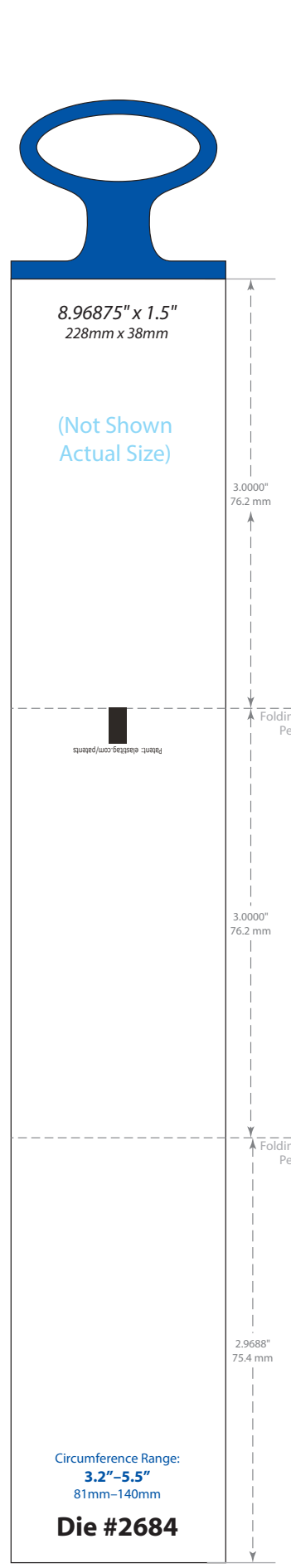
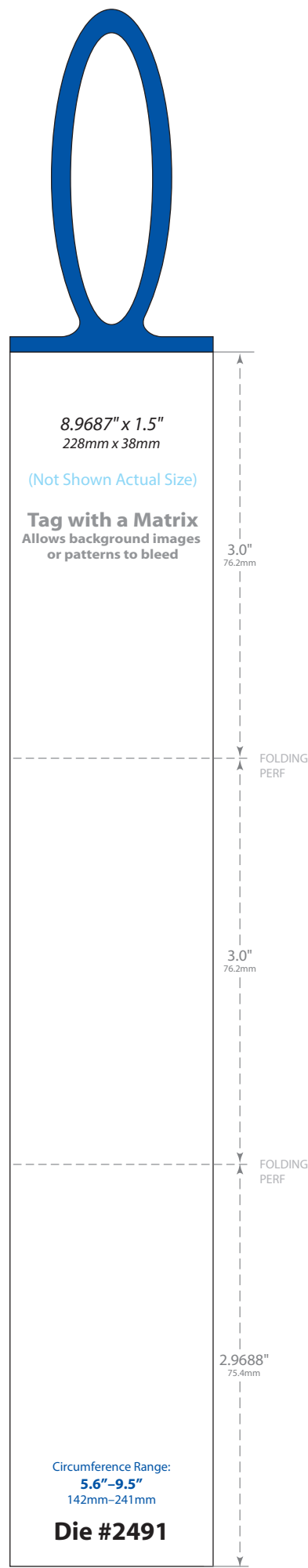

- 2214
- 2215
- 2491
- 2509
- 2564
- 2683
- 2684

- NON-MATRIX
- SPOOLED
- P.O.D. SPOOLED
- TOTE
- MATRIX
- MULTIPANEL**
- NF SPOOLED
- TAB
- DUO

2166  
2213  
2278  
2557

- NON-MATRIX
- SPOOLED
- P.O.D. SPOOLED
- TOTE
- MATRIX
- MULTIPANEL
- NF SPOOLED
- TAB
- DUO

**ElastiTag**  
BY BEDFORD

Updated: 10/04/21

Patent: elastitag.com/patents

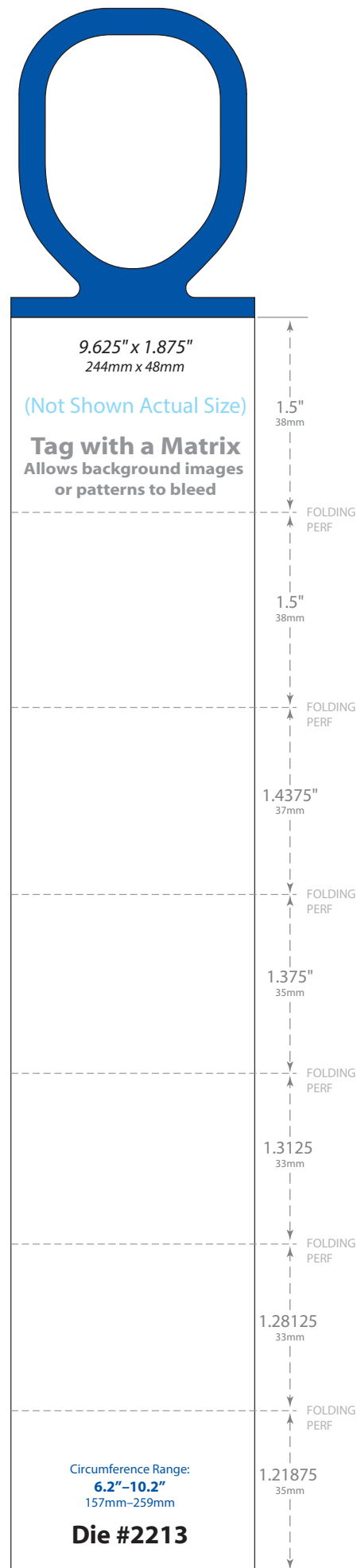

Single

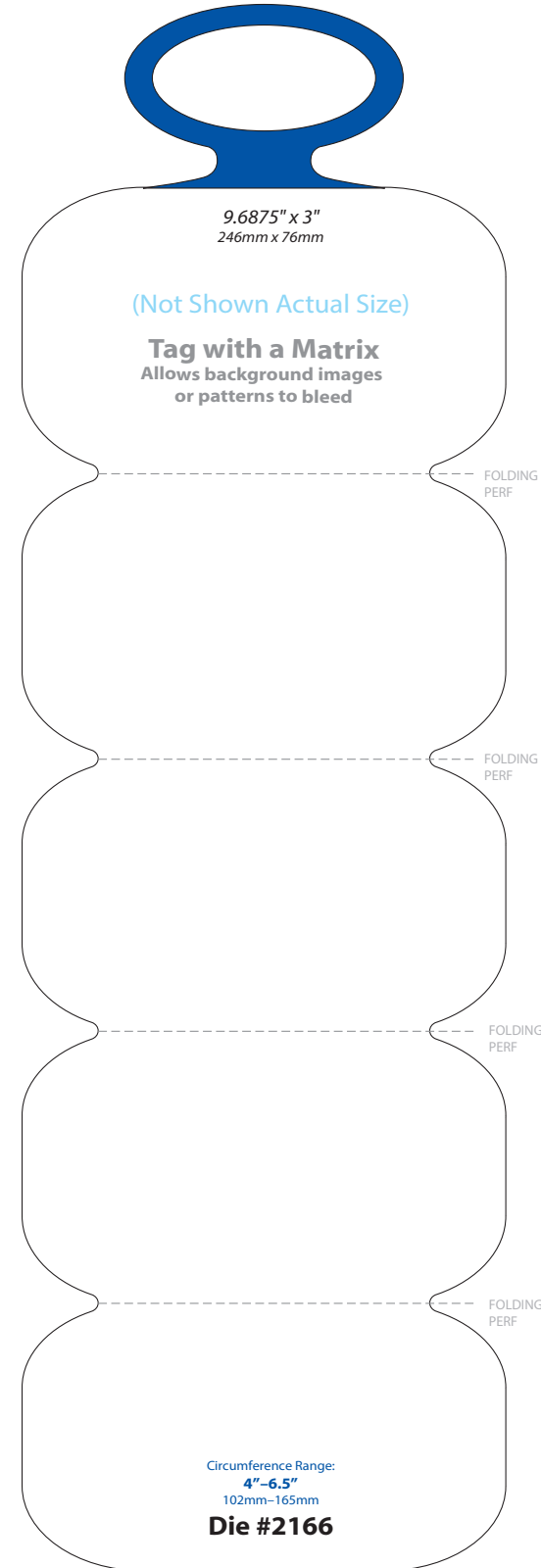

Single

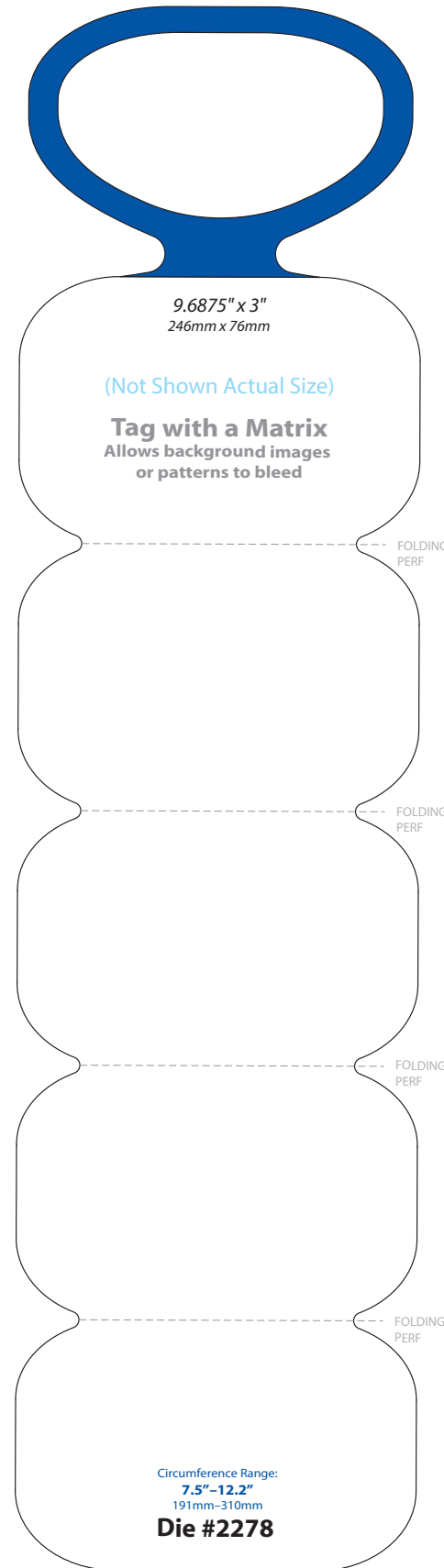

Single

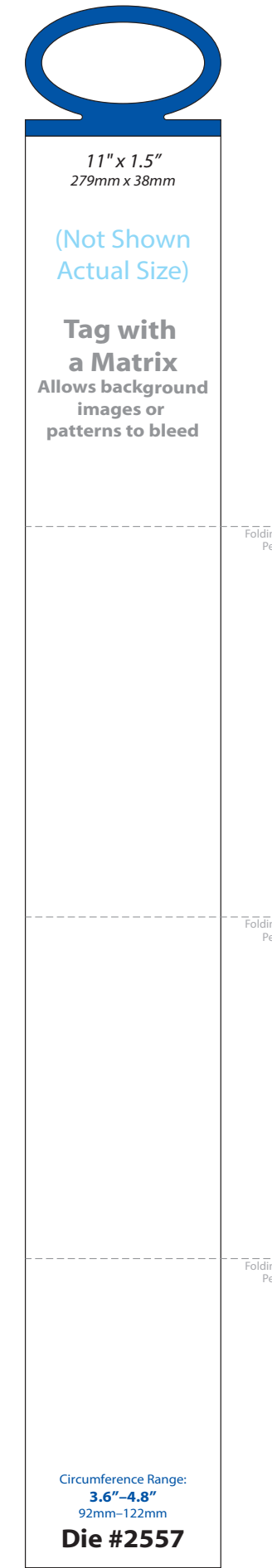

Single

2089  
2315  
2467  
2493

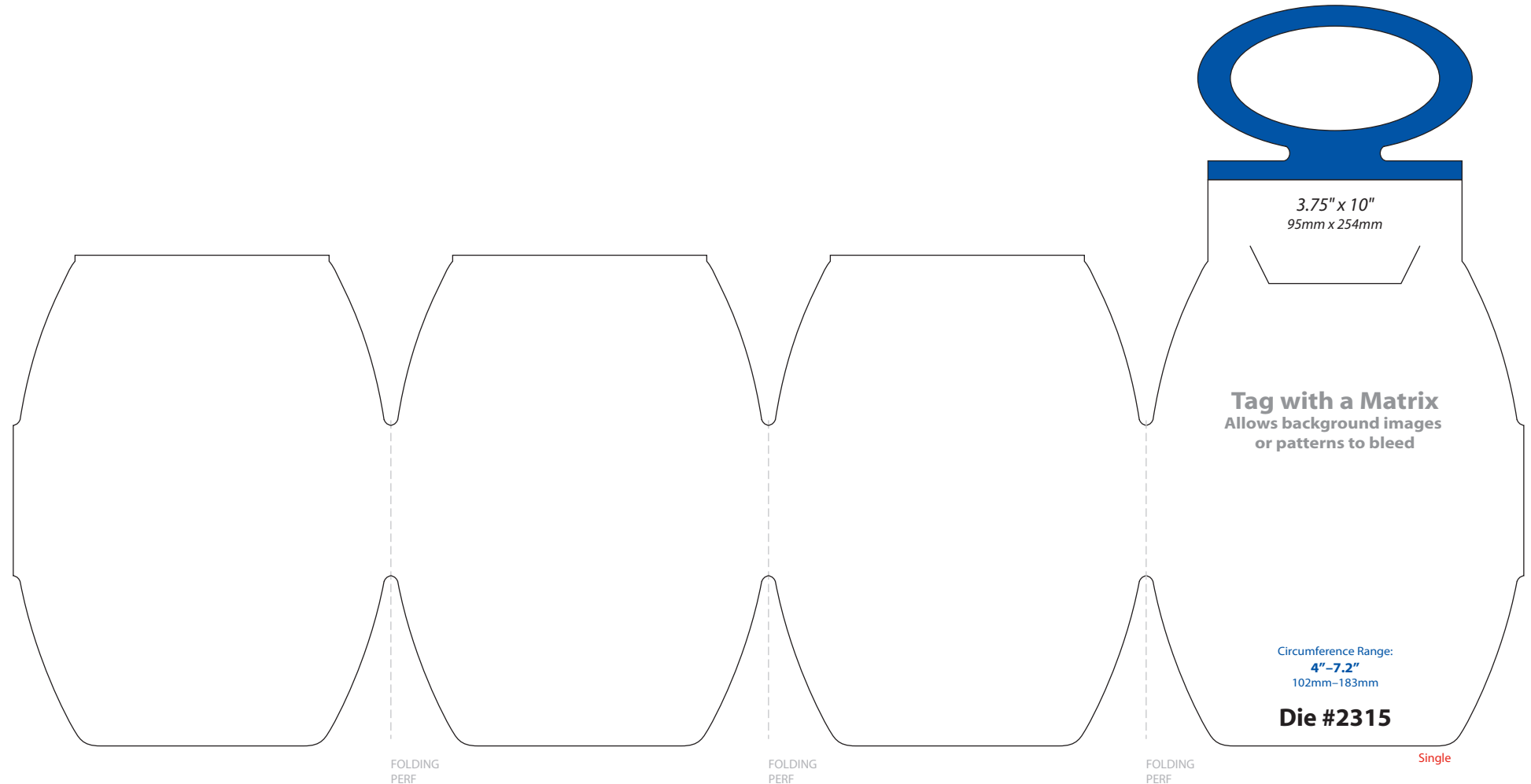
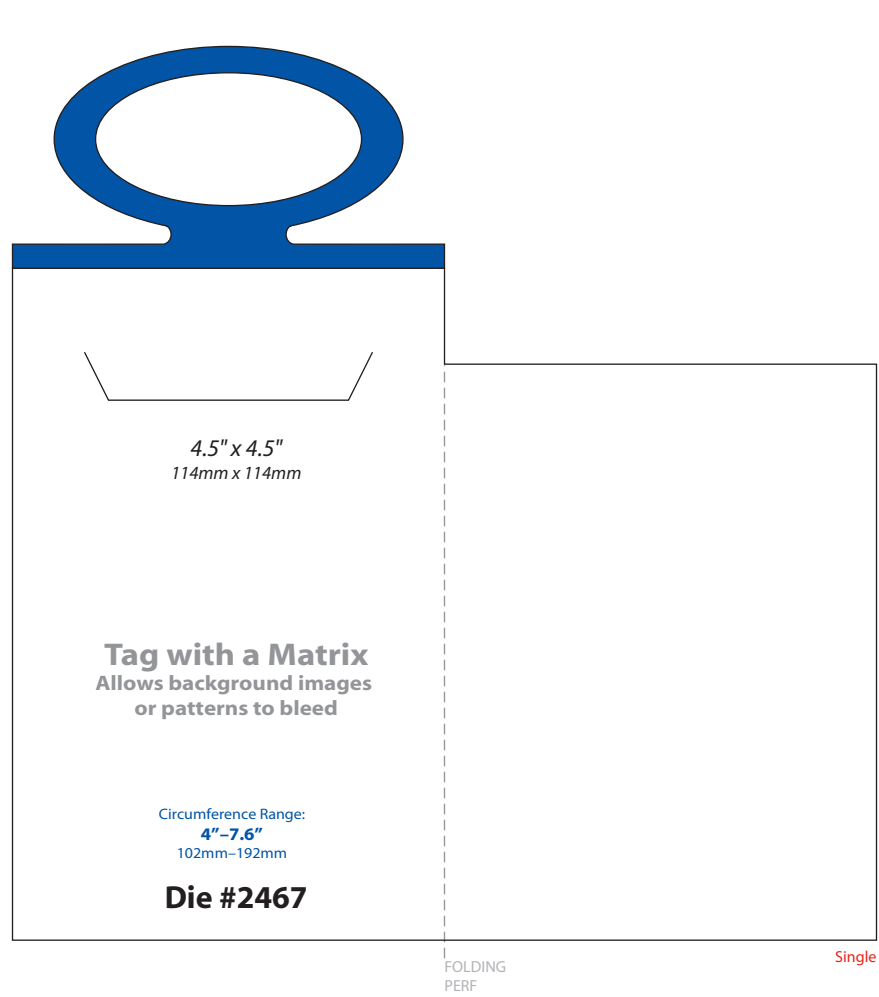
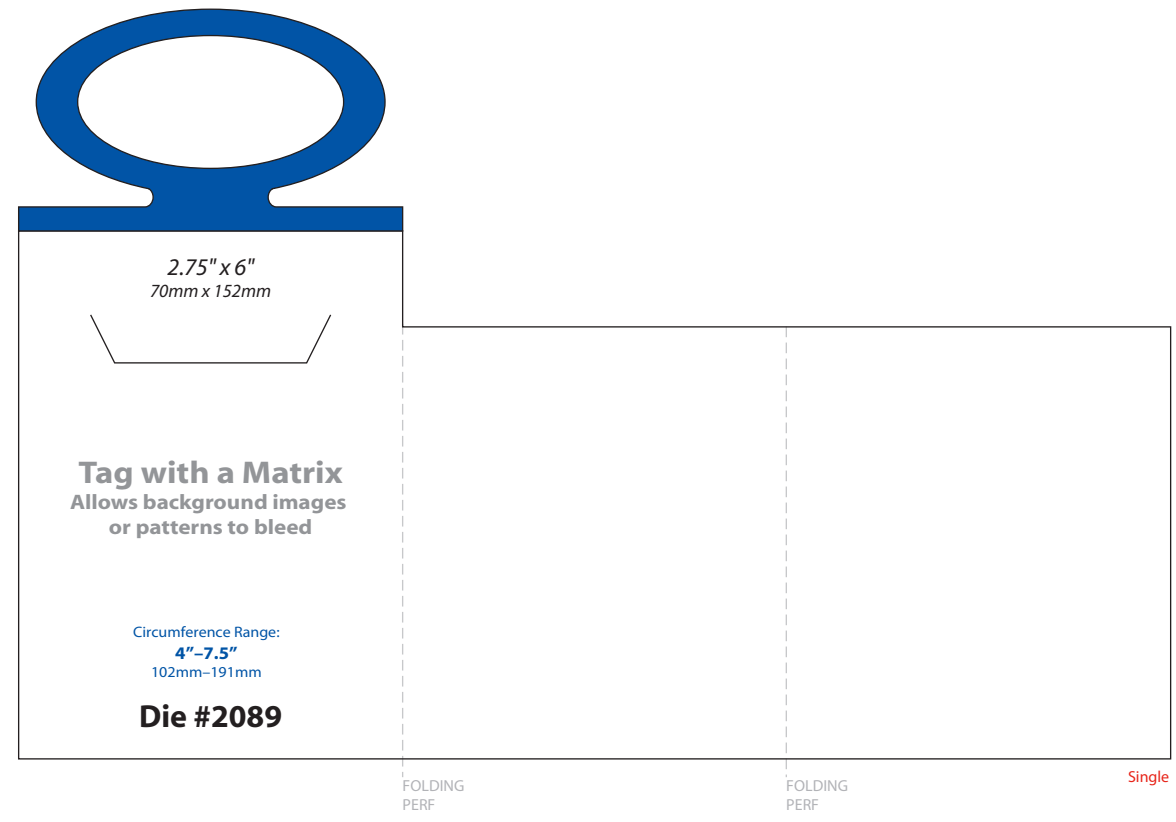
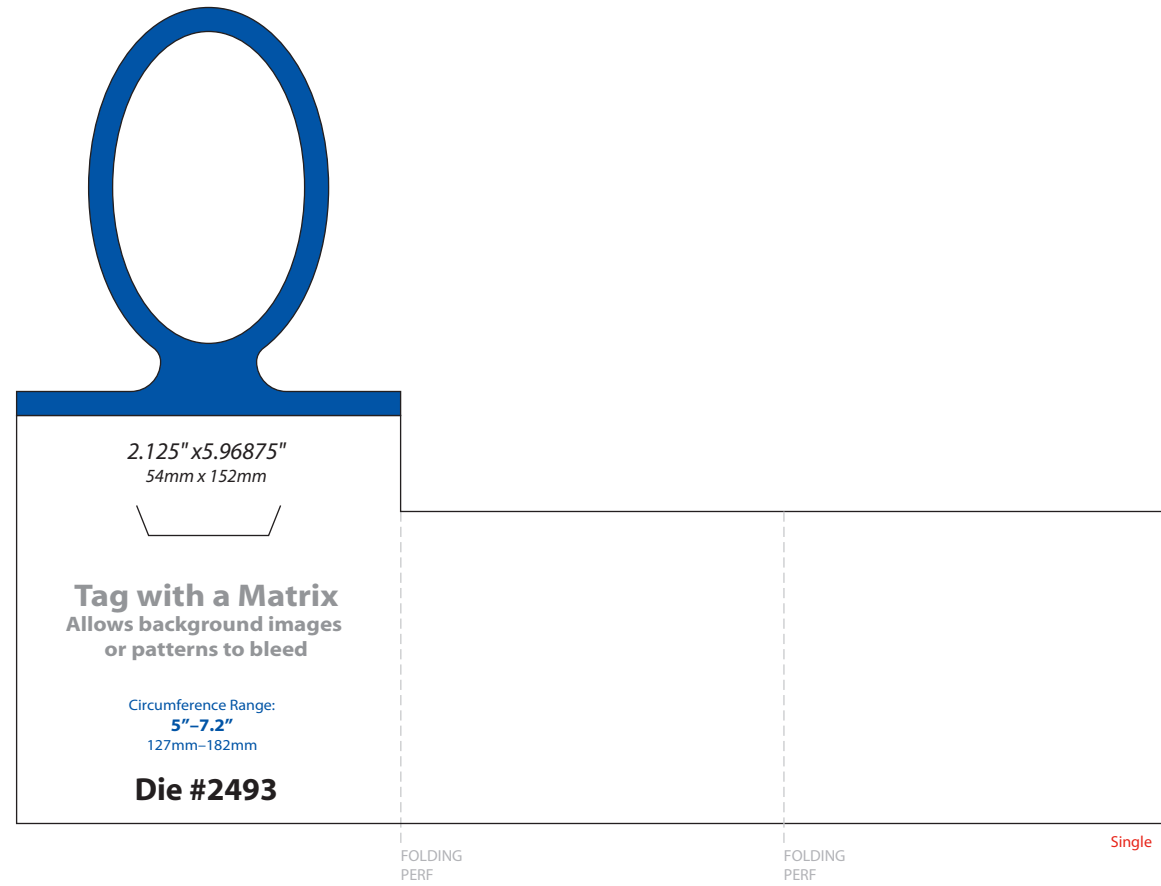

NON-MATRIX  
SPOOLED  
P.O.D. SPOOLED  
TOTE  
MATRIX  
MULTIPANEL  
NF SPOOLED  
TAB  
DUO

2657

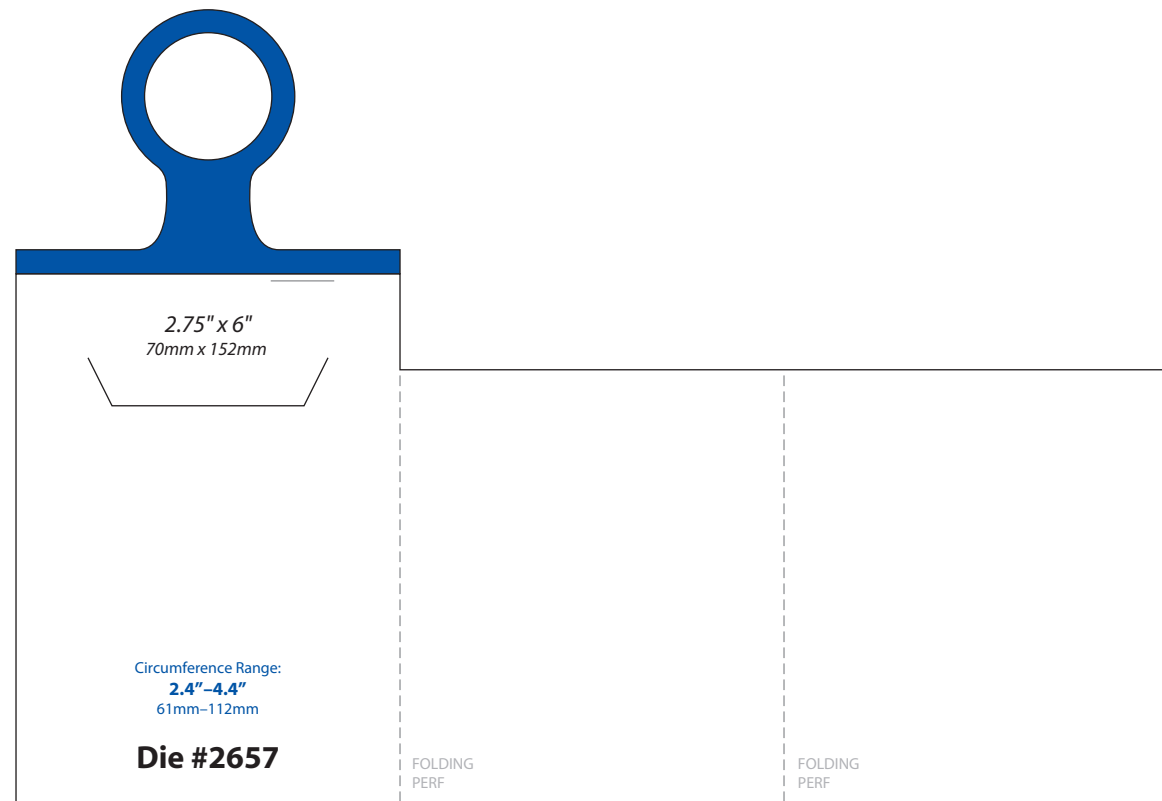

NON-MATRIX

SPOOLED

P.O.D. SPOOLED

TOTE

MATRIX

MULTIPANEL

NF SPOOLED

TAB

DUO

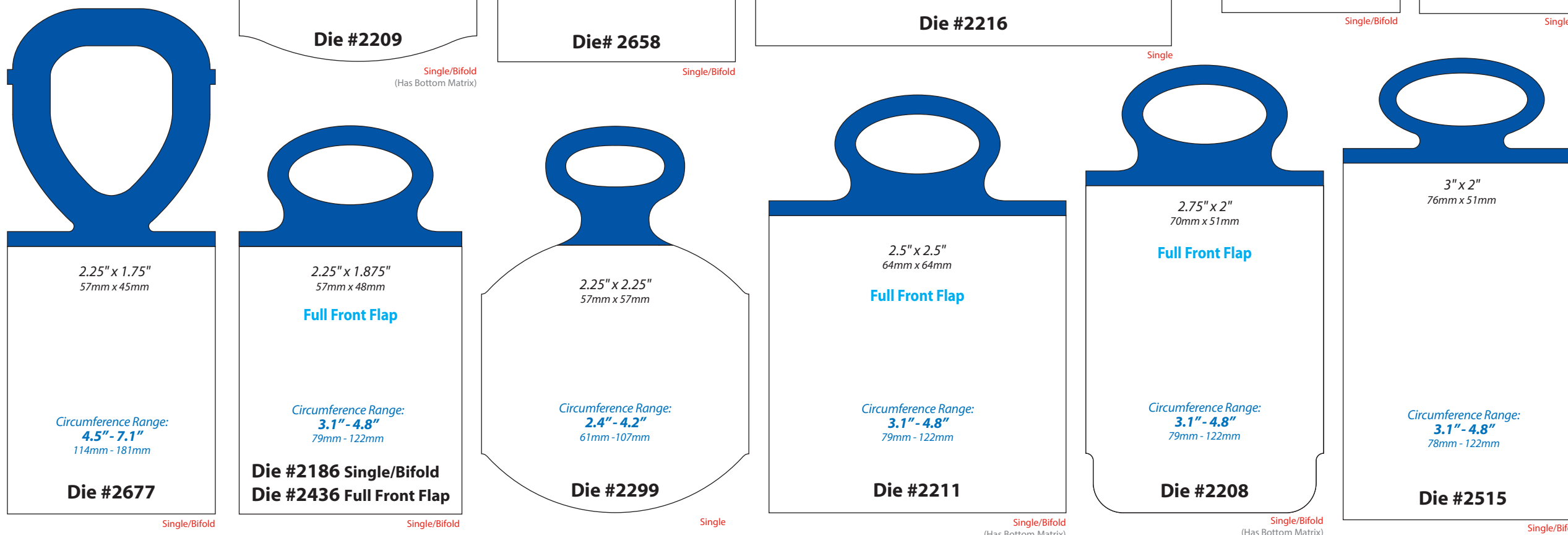
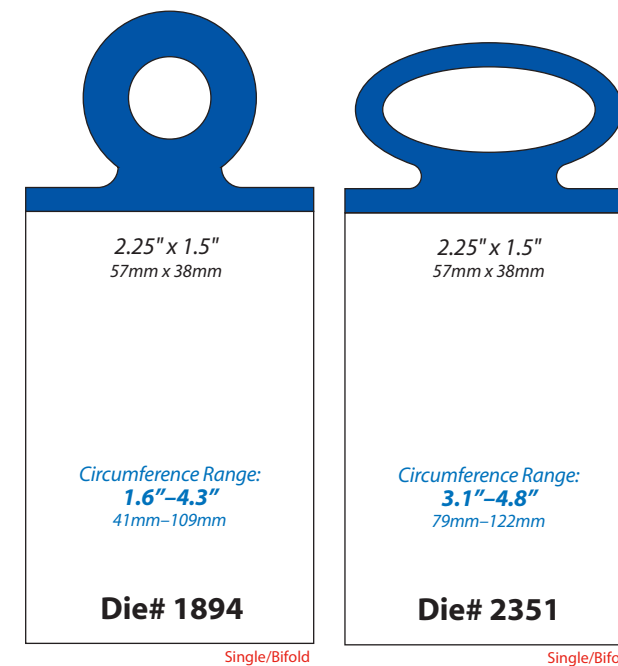
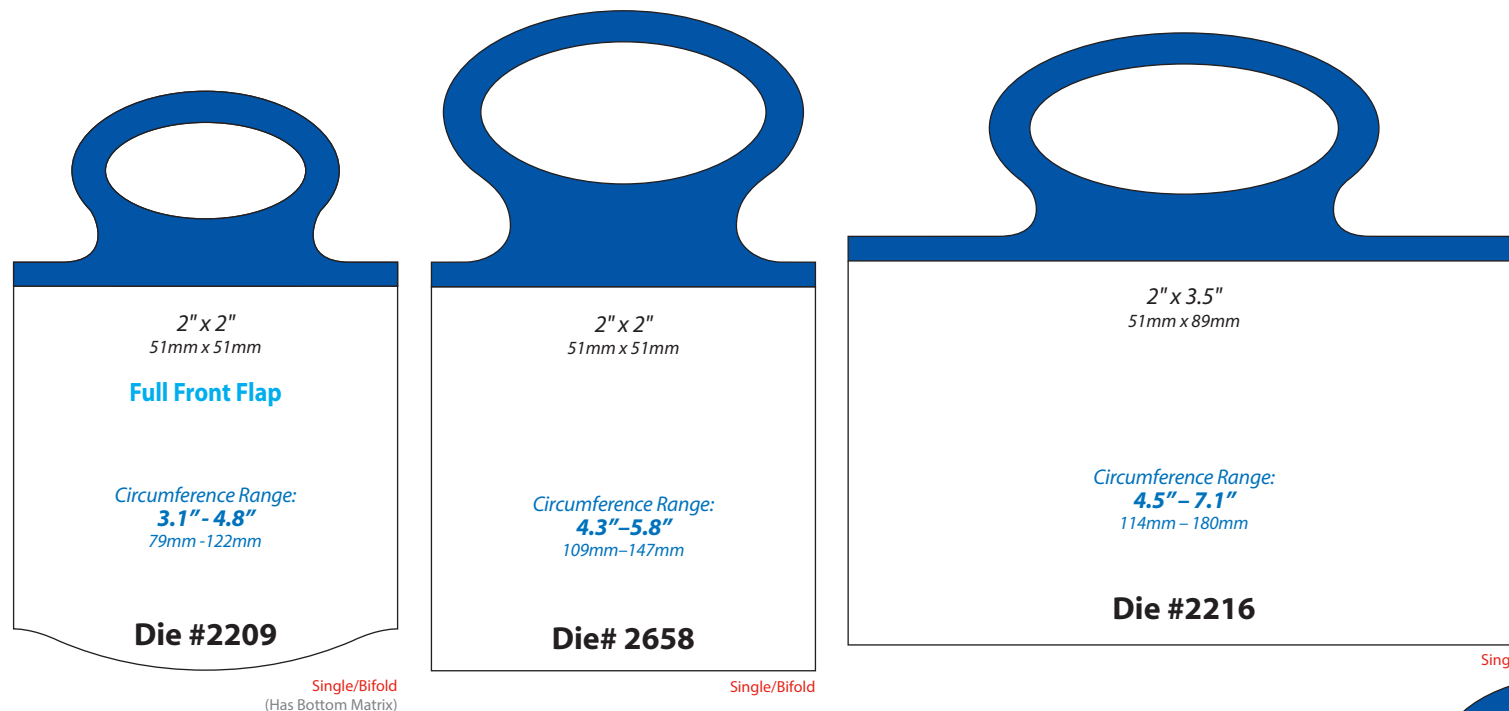

- 1894
- 2186
- 2208
- 2209
- 2211
- 2216
- 2299
- 2334
- 2351
- 2374
- 2375
- 2436
- 2454
- 2501
- 2515
- 2563
- 2658
- 2677

**STANDARD**  
Northfield  
ElastiTag®  
Applicator

- NON-MATRIX
- SPOOLED
- P.O.D. SPOOLED
- TOTE
- MATRIX
- MULTIPANEL
- NF SPOOLED
- TAB
- DUO

1984  
2054  
2664

**SHAPED**  
Northfield  
ElastiTag®  
Applicator

- NON-MATRIX
- SPOOLED
- P.O.D. SPOOLED
- TOTE
- MATRIX
- MULTIPANEL
- NF SPOOLED**
- TAB
- DUO

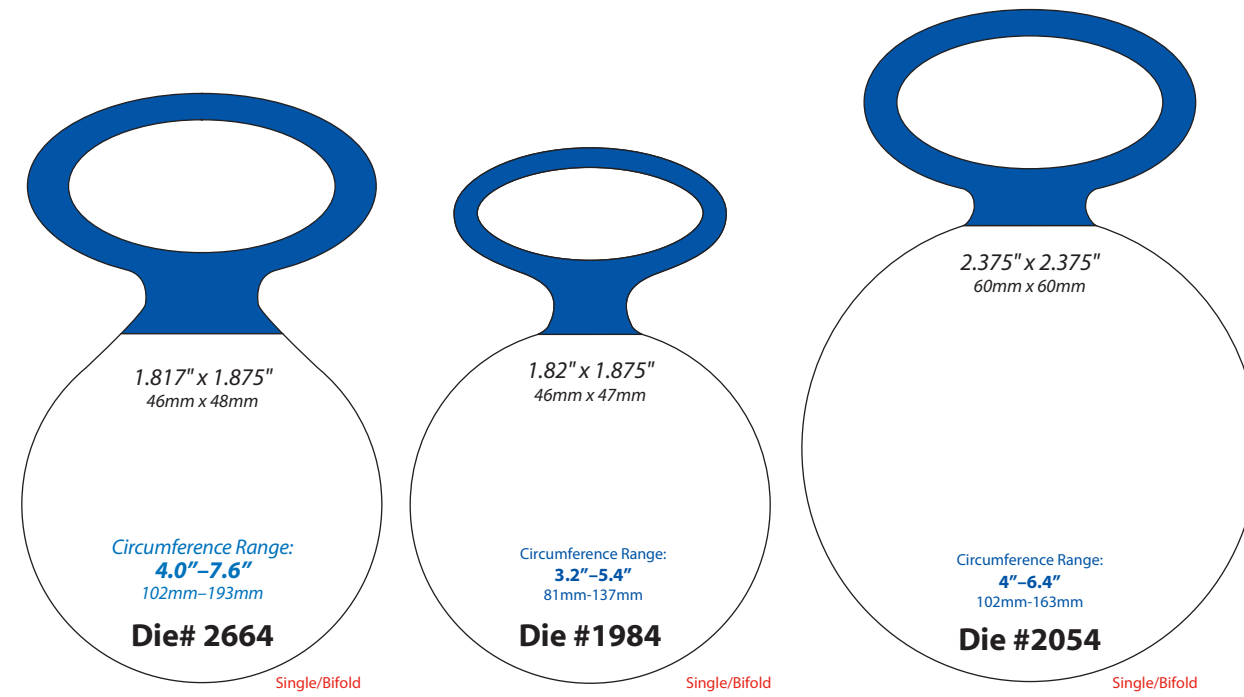

- 2102
- 2144
- 2145
- 2164
- 2312
- 2243
- 2347

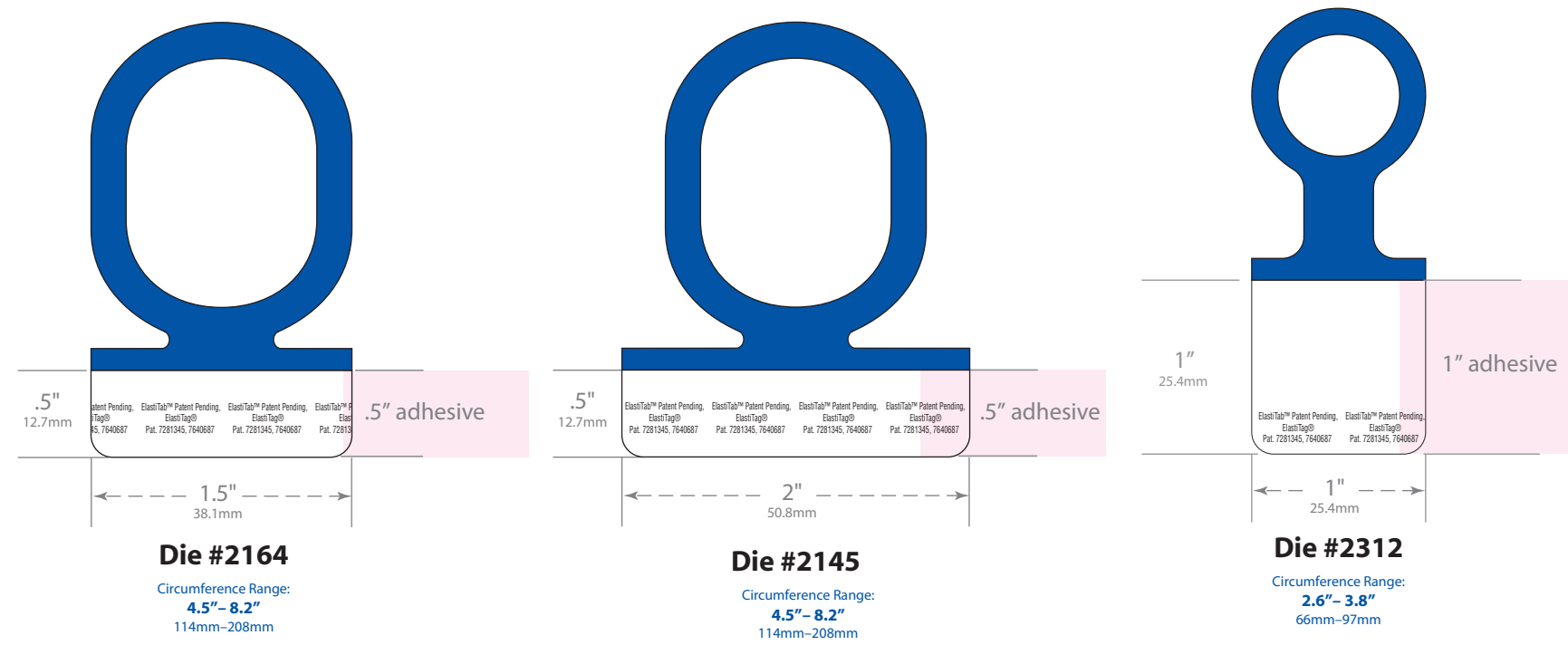
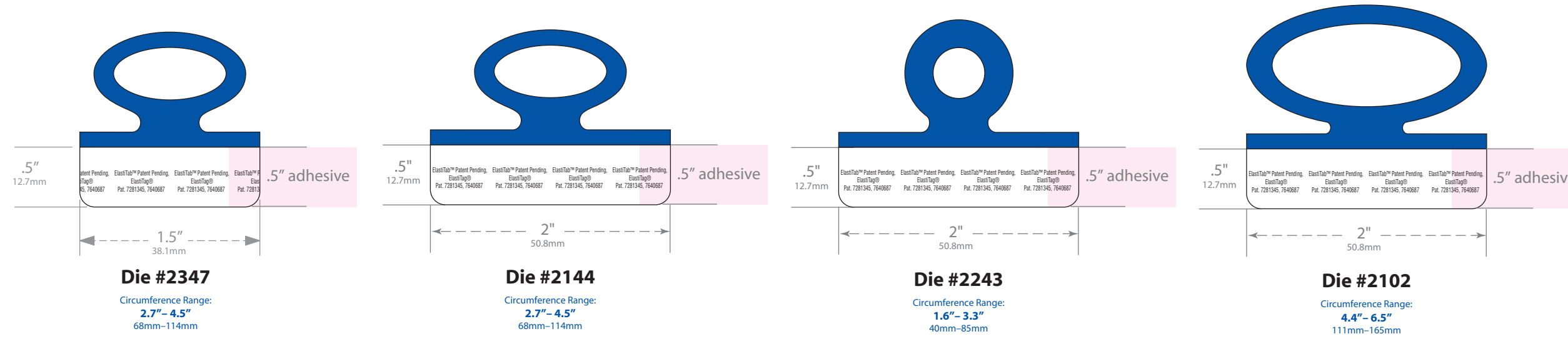

- NON-MATRIX
- SPOOLED
- P.O.D. SPOOLED
- TOTE
- MATRIX
- MULTIPANEL
- NF SPOOLED
- TAB
- DUO